

DO NOT SCALE DRAWING

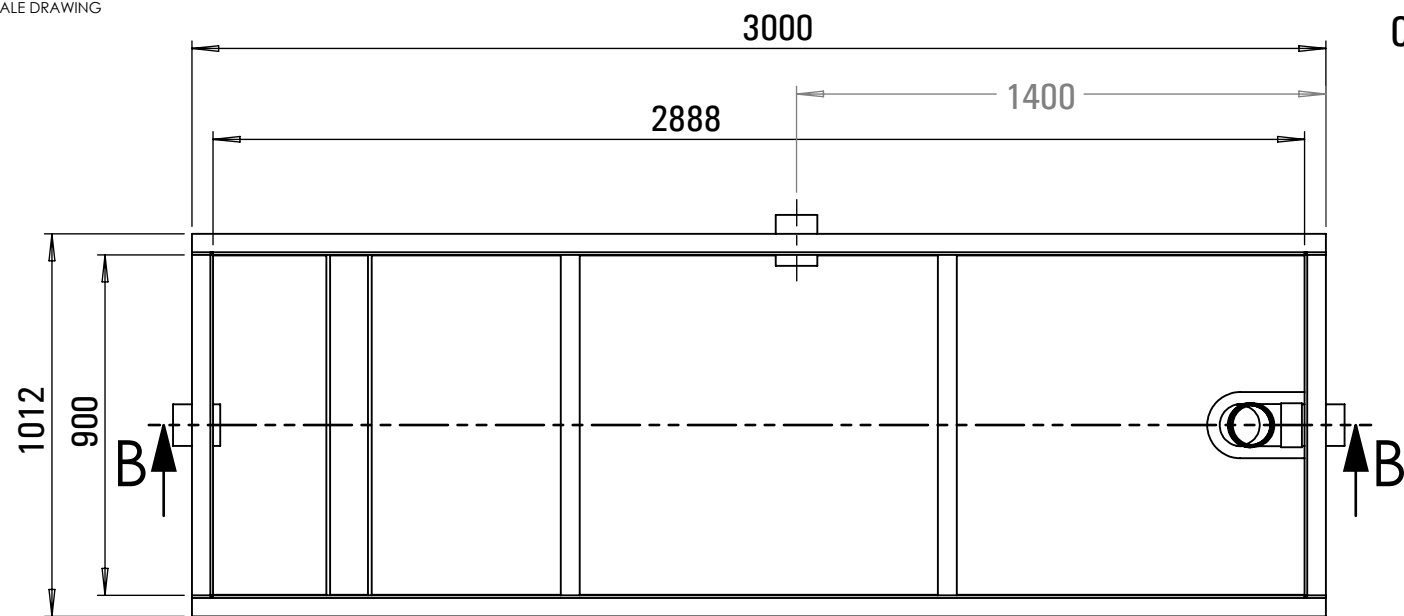

Cover Supplied Separately

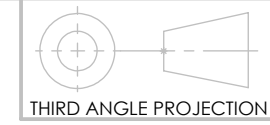
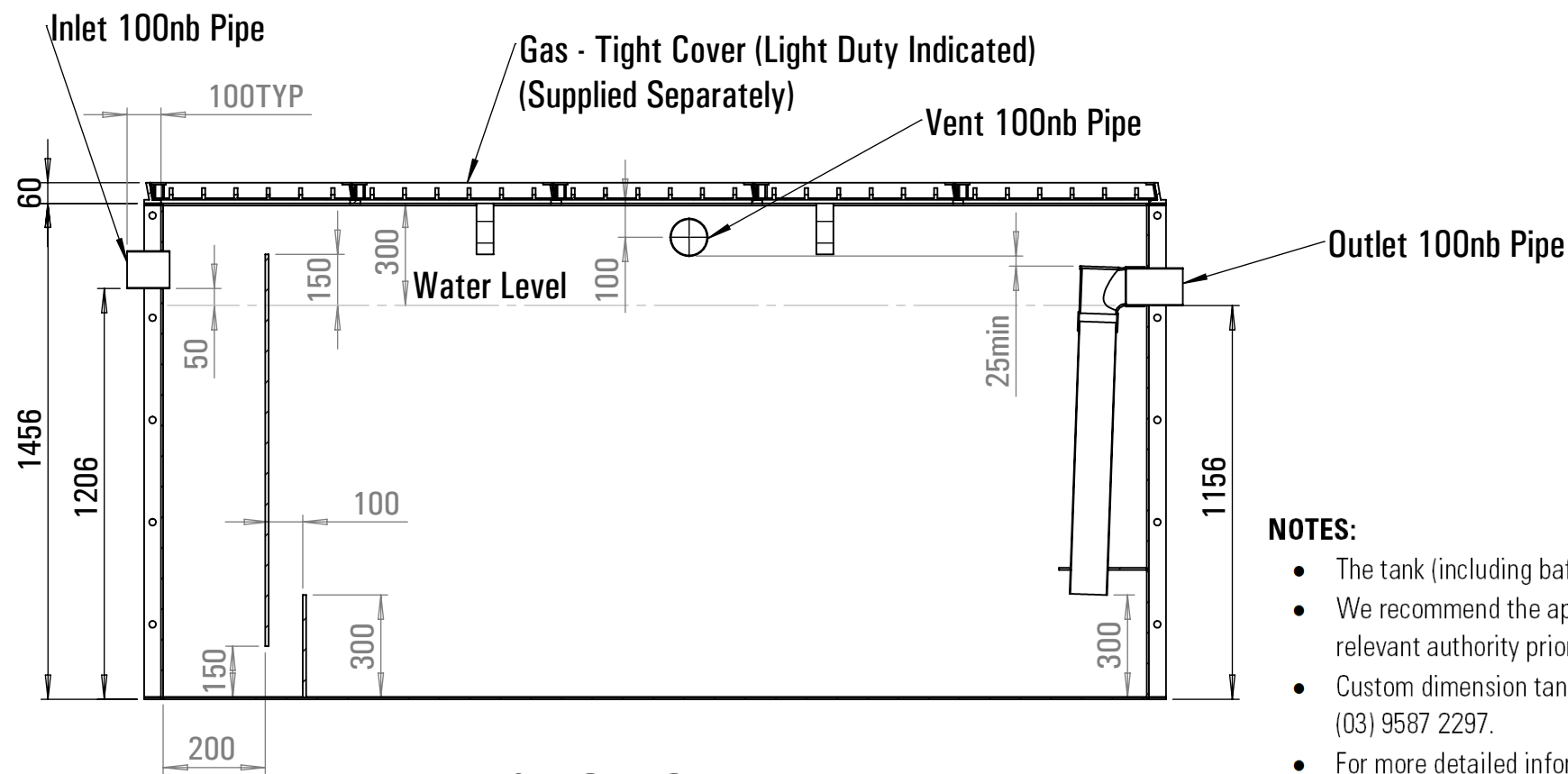
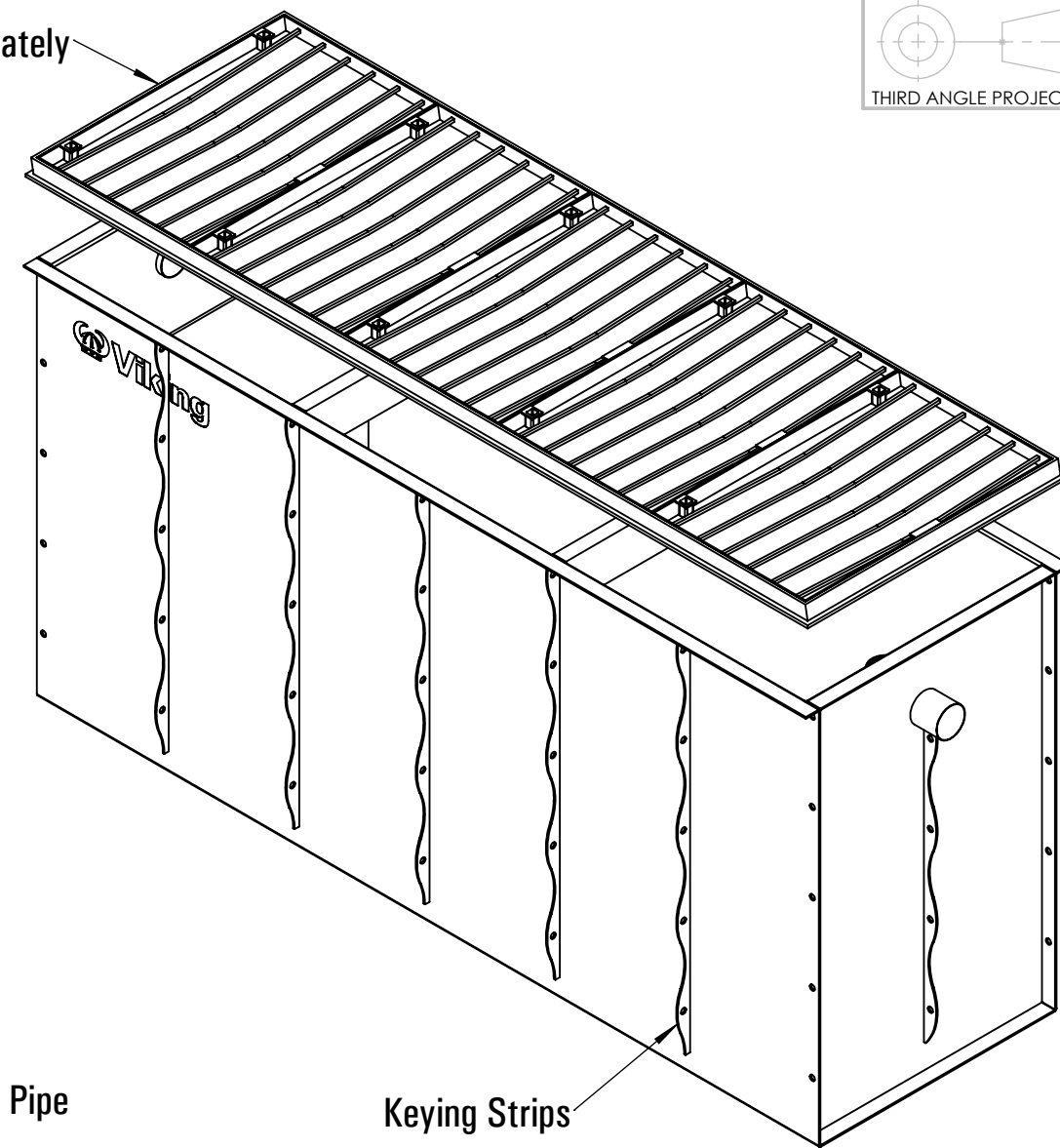

SECTION B-B

**NOTES:**

- The tank (including baffles, pipe and fittings) is constructed from polypropylene (PP).
- We recommend the appropriateness of the tank design, and its proposed location, be verified for use by the relevant authority prior to order placement.
- Custom dimension tanks can be made to order for situations limited by space. If required, call Viking Plastics on (03) 9587 2297.
- For more detailed information on installation and maintenance, please refer to the Installation and Maintenance Guidelines available on Viking Plastics' website: [www.vikingplastics.com.au/spec-sheets](http://www.vikingplastics.com.au/spec-sheets).

REV.	DESCRIPTION	APP.	DATE



Viking Plastics Engineering Pty Ltd  
 143 Woodlands Drive, Braeside, VIC 3195, Australia  
 P: +613 9587 2297 | E: [info@vikingplastics.com.au](mailto:info@vikingplastics.com.au)  
[www.vikingplastics.com.au](http://www.vikingplastics.com.au)

©2019

NAME	SIGNATURE	DATE
DRAWN PS		31-05-19
CHK'D		
APPV'D		
MFG		

This drawing is intended only for the use of the individual to whom it was forwarded by Viking Plastics Engineering Pty Ltd and contains information that is confidential and privileged. If you are not the intended recipient, you must not use, read, disclose, forward, copy or store any of the information. If you have received this drawing in error, please dispose of it and advise Viking Plastics +61 3 9587 2297.

TITLE: <b>3,000Lt Grease Interceptor Below Ground-Thin Skin Western Australia</b>	
DWG NO. <b>WP9BG-3000</b>	A3
SCALE:1:20	SHEET 2 OF 2