

**APPROXIMATE:**

WORKING CAPACITY = 7300L  
 SPILL CAPACITY = 3900L  
 SILT CAPACITY = 1980L  
 TOTAL MASS = 850KG  
 MATERIAL = FIBREGLOSS

REVISION HISTORY				
REV	DESCRIPTION	DESIGNER	CREATION DAT	CHECKED BY
1	INITIAL RELEASE	M.MAKIN	1/10/2015	

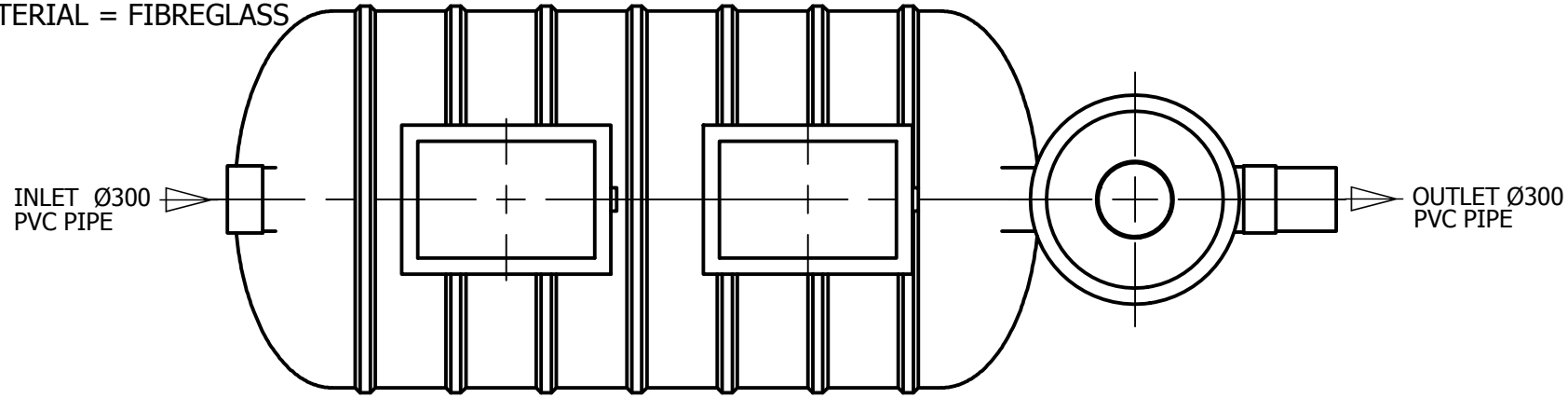

**PLAN VIEW**

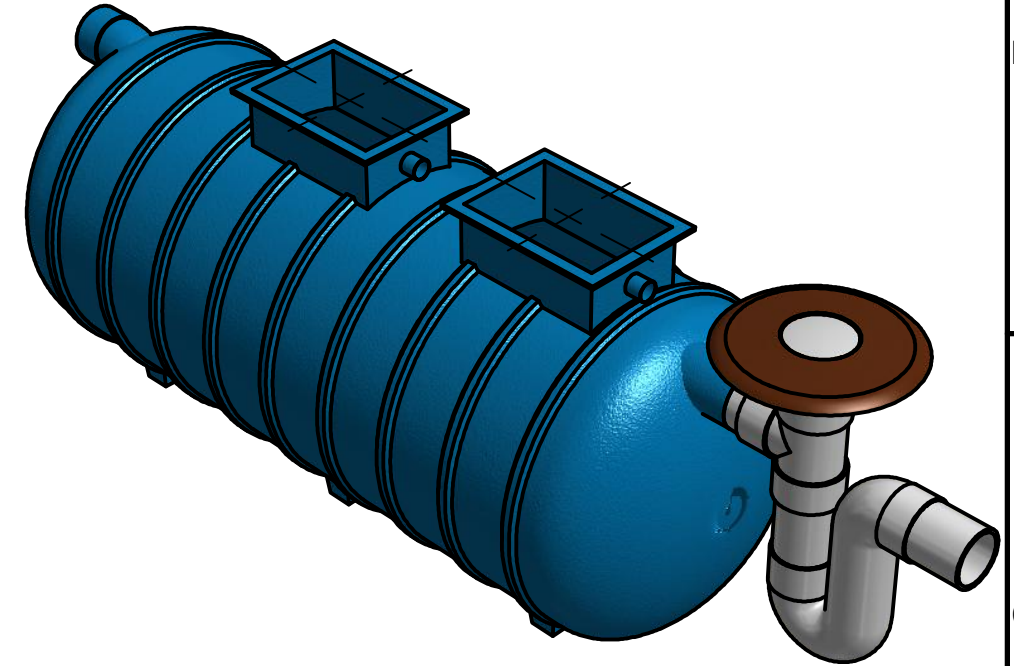

**ISOMETRIC VIEW**

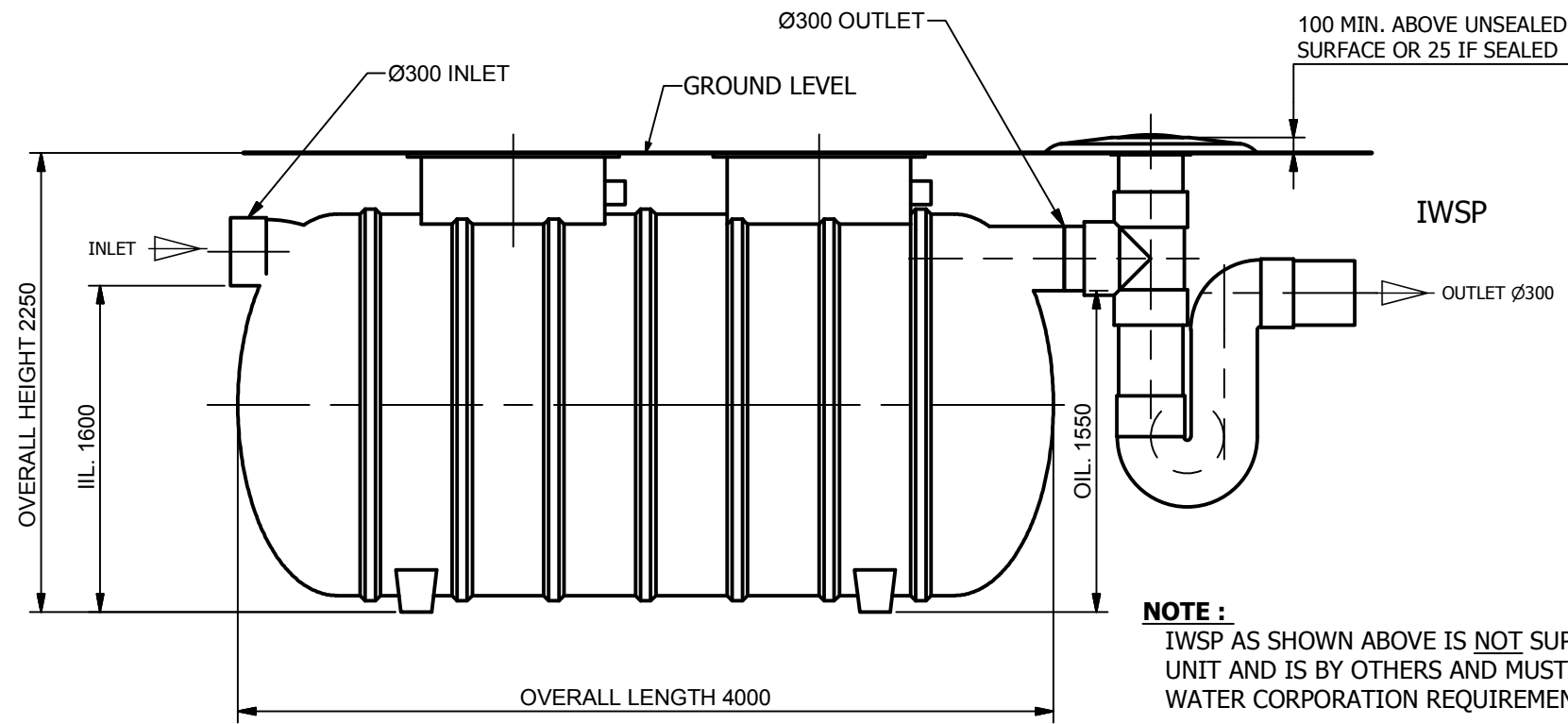

**ELEVATION VIEW**

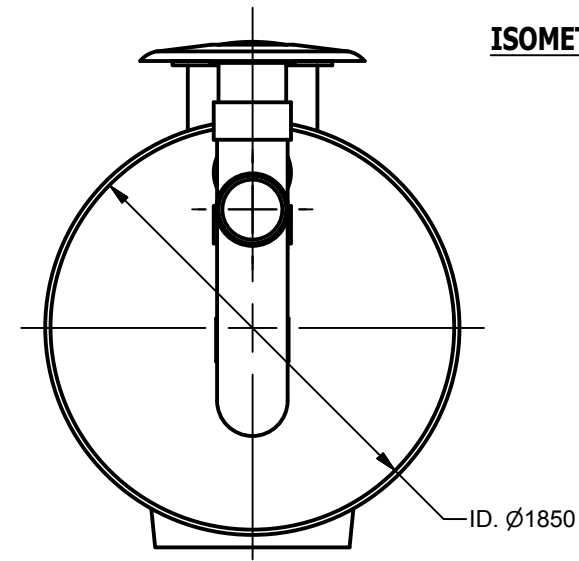

**SIDE VIEW**

**NOTE :**  
 IWSP AS SHOWN ABOVE IS NOT SUPPLIED WITH THE UNIT AND IS BY OTHERS AND MUST COMPLY TO WATER CORPORATION REQUIREMENTS

**ISSUE FOR APPROVAL**  
 NOT FOR CONSTRUCTION

TOLERANCE: ALL DIMENSIONS 10mm UNLESS OTHERWISE STATED.

CLIENT:

DISTRIBUTOR :



Modal Crescent (Cnr Baile Rd.), Canning Vale, WA 6155  
 T: 1800 335 550 F: +61 (0) 8 9356 5255

CONFIDENTIAL - The drawings must not be disclosed to any third parties without written permission from SPEL Environmental Sydney. Unauthorised disclosure may result in prosecution.  
 © SPEL Environmental - This drawing is the property of SPEL Environmental ABN: 83 151 832 629 and is subject to return on demand. It is submitted for the use only in connection with the proposal and contracts of SPEL Environmental with the expressed conditions that it is not to be reproduced or copied in any form. This data must only be used in accordance with our standard terms and conditions.  
 © Copyright  
 SPEL Environmental accepts no responsibility for any loss or damage resulting from any person acting on this information. The details and dimensions contained in this document may change, please check with SPEL Environmental for confirmation of current specifications.

Drawn	Date
M.MAKIN	1/10/2015
Check	Date
Verified	Date
Approved	Date
Request No.	
RN2006	

**SPEL**  
 ENVIRONMENTAL  
 INTEGRATED WATER SOLUTIONS

100 Silverwater Road Silverwater NSW 2128  
 PH: 1300 773 500 | E: sales@spel.com.au  
 www.spel.com.au

PROJECT :			
TITLE SPEL PURCEPTOR P.020.C1.2C.A.300 TRADE WASTE PRE-TREATMENT GENERAL ARRANGEMENTS			
SCALE	N.T.S	SIZE	A3
SHEET	1	REV	1
CUSTOMER CODE :		DWG No. SP15-PC10780-PD	

D:\Vault\Working Folder\Designs\SPEL\PRODUCTS\PURCEPTOR\GRAVITY DISCHARGE\WATER\_CROP\SP15-PC10780-PD.dwg