

# How to provide as constructed information and interpretation of sewer plans

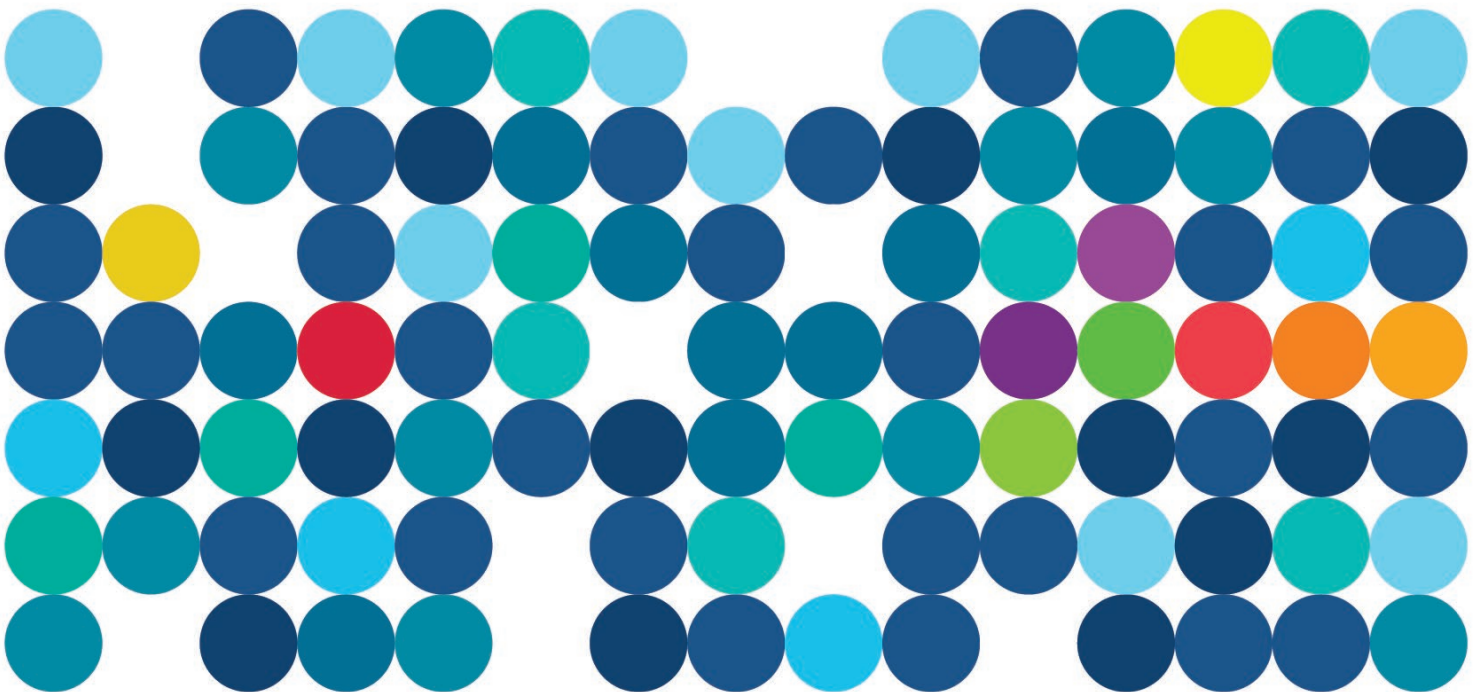



Table of Contents

<b>1</b>	<b>Sewer Junction Cut Ins and As Constructed .....</b>	<b>3</b>
1.1	Overview - As constructed procedure for cutting in a new sewer junction	3
1.2	Procedure for Sewer Junction As Constructed – Step 1	3
1.3	Measuring offtake position (Water Corporation)	4
1.4	Procedure for Sewer Junction As Constructed – Step 2 (Plumber)	5
1.1.	Example Sewer Junction As Constructed form (Plumber)	6
1.1.	Minor Works As Constructed (Water Corporation Use Only)	7
1.2.	Multiple rising shaft property connections	8
<b>2</b>	<b>Guide for measuring property junctions and inspection shafts.....</b>	<b>9</b>
1.3.	Sewer in road reserve, access chamber or maintenance shaft.	9
2.2	Sewer inside properties access chamber or maintenance shaft	10
2.3	Junction extends past upstream access chamber or maintenance shaft (Scenario 1)	11
2.4	Junction extends past upstream access chamber or maintenance shaft (Scenario 2).	12
2.5	Inspection shaft square to property boundary	13
2.6	Inspection shaft angled to property boundary	14
<b>3</b>	<b>General Information .....</b>	<b>15</b>
3.1	Sewer general layout (access chamber to access chamber)	15
3.2	Pipe grade information	16
3.3	Locating sewers and general information (1).	17
3.4	Locating sewers and general information (2).	18
3.5	Locate inspection shaft.	19
3.6	Junction location (Example 1)	20
3.7	Junction location (Example 2)	21
3.8	Calculation of sewer grades (1)	22
3.9	Calculation of sewer grades (2)	23
<b>4</b>	<b>Revisions .....</b>	<b>24</b>



# 1 Sewer Junction Cut Ins and As Constructed

## 1.1 Overview - As constructed procedure for cutting in a new sewer junction

- Plumber or Owner/Developer submits an application for a new sewer junction connection and pays associated fees. The work order is placed on HOLD  
[Sewer-junction-application.pdf \(watercorporation.com.au\)](#)
- Licensed Plumber excavates main sewer.  
NOTE: Excavation must be safe for entry. Water Corporation reserves the right to refuse entry to the excavation if it is in anyway considered unsafe to do so.
- Plumber calls 131395 when the site is ready for the junction to be installed and the work order is taken off hold to schedule the work.
- Water Corporation install take junction to the main sewer.
- Water Corporation measure off-take junction position relative to the downstream access chamber or maintenance shaft. If unable to obtain a measurement to these, the off-take junction position is to be located relative to the property boundaries.
- Water Corporation to record measurement/s on the “Minor Works As Constructed – Sewer” worksheet.
- If the junction requires further extension, or “ins and ups” these are to be constructed by the Licensed Plumber.
- The Licensed Plumber is required to obtain a copy of the “[Sewer Junction As Constructed](#)” details.
- The Licensed Plumber will extend the junction and bring the pipe in and up within the property and will record these measurements on the above-mentioned form.

The Licensed Plumber will complete the details on this form and submit to:  
[asset.registration@watercorporation.com.au](mailto:asset.registration@watercorporation.com.au)

## 1.2 Procedure for Sewer Junction As Constructed – Step 1

- Water Corporation install take-off junction
- Water Corporation take measurement to the off-take junction from the downstream access chamber or maintenance shaft and record this on the “Minor Works As Constructed – Sewer” worksheet (See page 7). Additional information such as date constructed, location work order etc must also be completed.

**Note:**

- (a) If a downstream access chamber or main sewer is not accessible then the junction off take is to be measured relative to the property boundaries.
  - (b) If the junction cut in is on an inspection shaft sewer (IS) then the distance measurement is to be taken from the intersection of the inspection shaft sewer and the main sewer where this is possible.
  - (c) Where this is not possible, due to obstructions etc, it is permissible to measure the junction cut in relative to the property boundaries.
- Water Corporation to submit this plan to [asset.registration@watercorporation.com.au](mailto:asset.registration@watercorporation.com.au)



### 1.3 Measuring offtake position (Water Corporation)

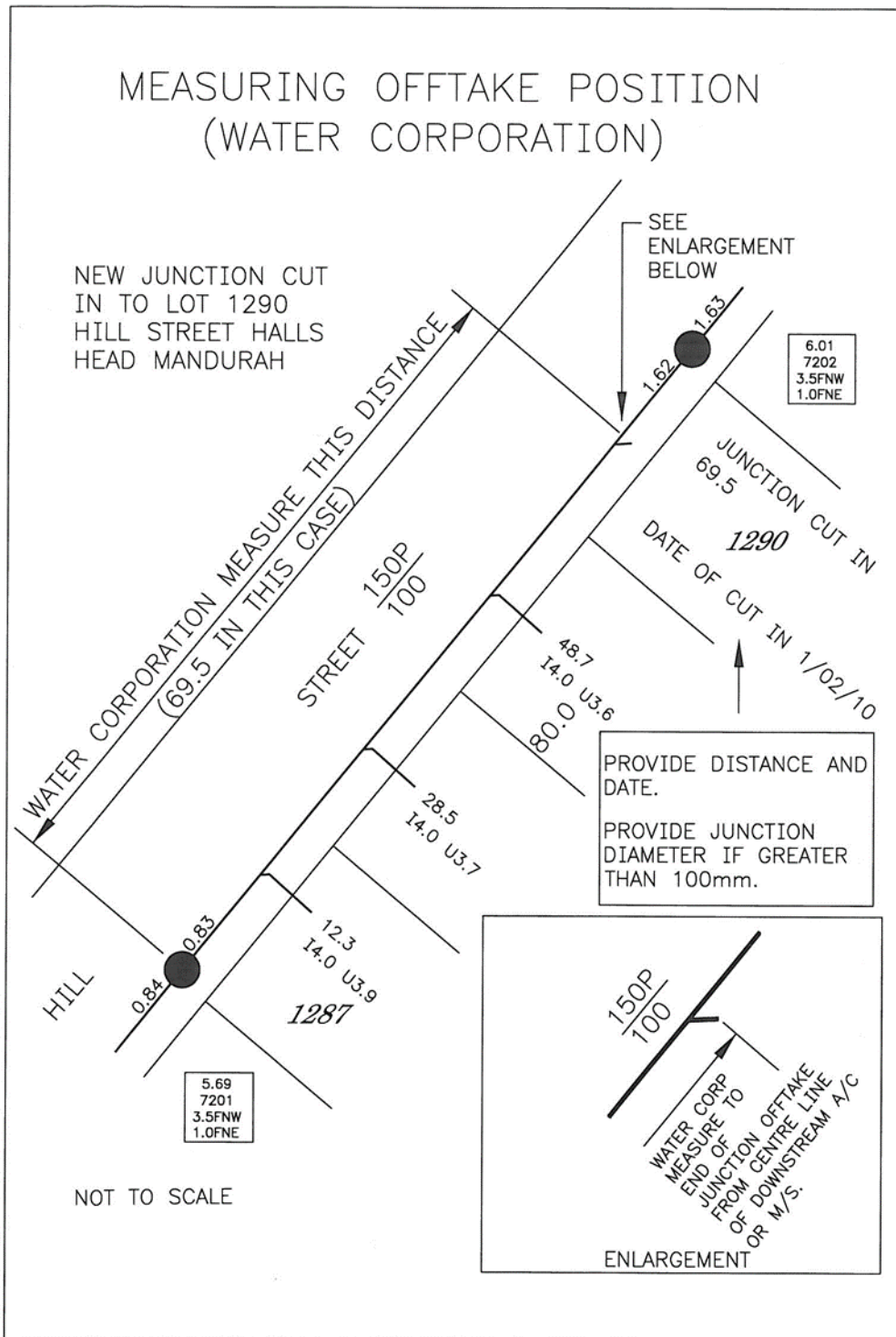



## 1.4 Procedure for Sewer Junction As Constructed – Step 2 (Plumber)

- If the junction requires further extension, or “ins and ups” these are to be constructed by the Licensed Plumber.
- The Licensed Plumber is required to obtain a copy of the “Sewer Junction As Constructed” form, complete the details and reference the work order number for the junction cut in completed by Water Corporation (See example on page 6).
- The Licensed Plumber will construct the junction extension and/or “ins and ups” as required and will record these measurements on the As Constructed Water and Sewer form (as per below).
- The Licensed Plumber will complete the details on this form and should submit the fully completed form to [building.services@watercorporation.com.au](mailto:building.services@watercorporation.com.au) or by post to Water Corporation, Development Services Branch, PO Box 100, Leederville WA 6902
- If the junction is required for a subdivision, the as-constructed should be submitted to the Land Servicing Advisor as directed in the Land Development Agreement; e-mail to [land.servicing@watercorporation.com.au](mailto:land.servicing@watercorporation.com.au)

In the example shown below, following on from the Water Corporation cut in junction (as per diagram on page 4), the Plumber has extended the offtake junction by 0.5m making a total distance of 70.0m from the downstream access chamber. This is the distance that the plumber records on the form.

The plumber has also extended the junction 4.0m into the block and has placed a 3.5m riser on the end of the junction. This is to be shown as I4.0 & U3.5 on the Sewer Junction As Constructed form.

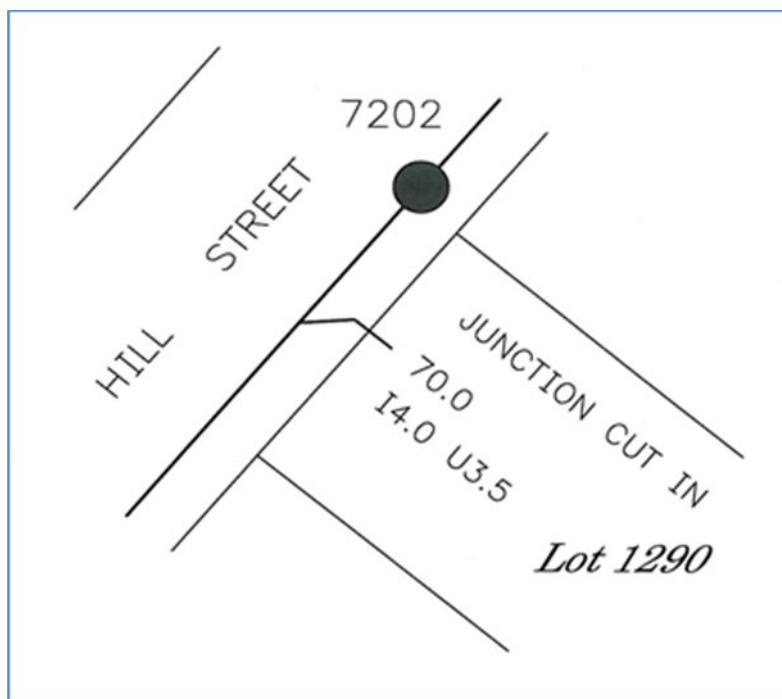



### 1.1. Example Sewer Junction As Constructed form (Plumber)

<b>Sewer Junction - AS CONSTRUCTED</b>					
USE BLACK INK OR BLACK BALL POINT PEN ONLY					
PLEASE PRINT CLEARLY		PLUMBERS DETAILS – COMPLETE ALL FIELDS		FOR OFFICE USE ONLY	
Lot No.	Strata Lot No	Licenced Plumbers Name	Licence Number	F/B Folio / Page	
House No	Street			Sewer District	
Town / Suburb		PLB Notice of Intention		Account No	
Owners Name				File / WAPC. Ref	
				Work Order #	
Show distance from down stream A/C, M/S or I.S. intersection (if none available provide location sketch from property boundary).		Provide a brought <b>IN</b> measurement from the sewer main centre line to the connection end point within the property		Provide a brought <b>UP</b> measurement from the invert of the sewer main to the connection end point within the property.	
<b>I CERTIFY THAT THIS PLAN SHOWS THE LAYOUT AND DIMENSIONS OF THE PROPERTY SEWER CONSTRUCTED BY ME OR UNDER MY SUPERVISION AT THE ABOVE ADDRESS SHOWN.</b>					
LICENCED PLUMBER'S SIGNATURE _____				DATE / /	

Please return the fully completed as constructed to the Water Corporation at;  
 POST Development Services Branch, Water Corporation, PO Box PO Box 100 Leederville WA 6902  
 EMAIL [building.services@watercorporation.com.au](mailto:building.services@watercorporation.com.au)





### 1.1. Minor Works As Constructed (Water Corporation Use Only)



**WASTEWATER**  
Minor works as constructed

S 00000

Work order number _____	Crew _____	Region _____
Date completed _____	Team Leader name _____	
	Signature _____	

**Cut in junction**

**Repair pipe**

Upstream A/C number \_\_\_\_\_ or IO \_\_\_\_\_

Downstream A/C number \_\_\_\_\_

**Lower A/C**

**Raise A/C**

A/C number \_\_\_\_\_

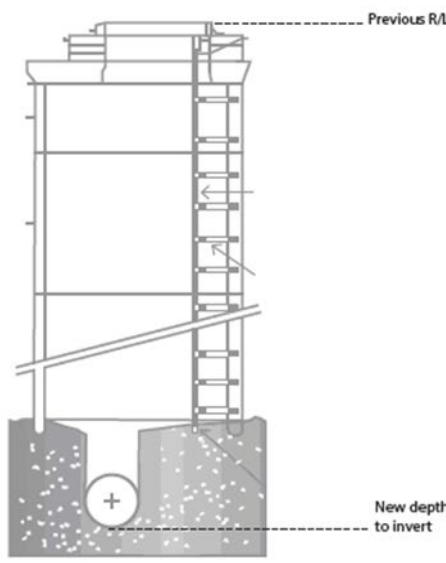

**New access chamber / pipe construction**

Pipe size	_____
Pipe material	_____
Length	_____
U/S invert	_____
D/S invert	_____
Alignment	_____

**Provide details**

Lot/Hse No \_\_\_\_\_

Street name: \_\_\_\_\_

Street name: \_\_\_\_\_

Please forward completed minor works as constructed by email to [spatial-datacapture@watercorporation.com.au](mailto:spatial-datacapture@watercorporation.com.au)



## 1.2. Multiple rising shaft property connections

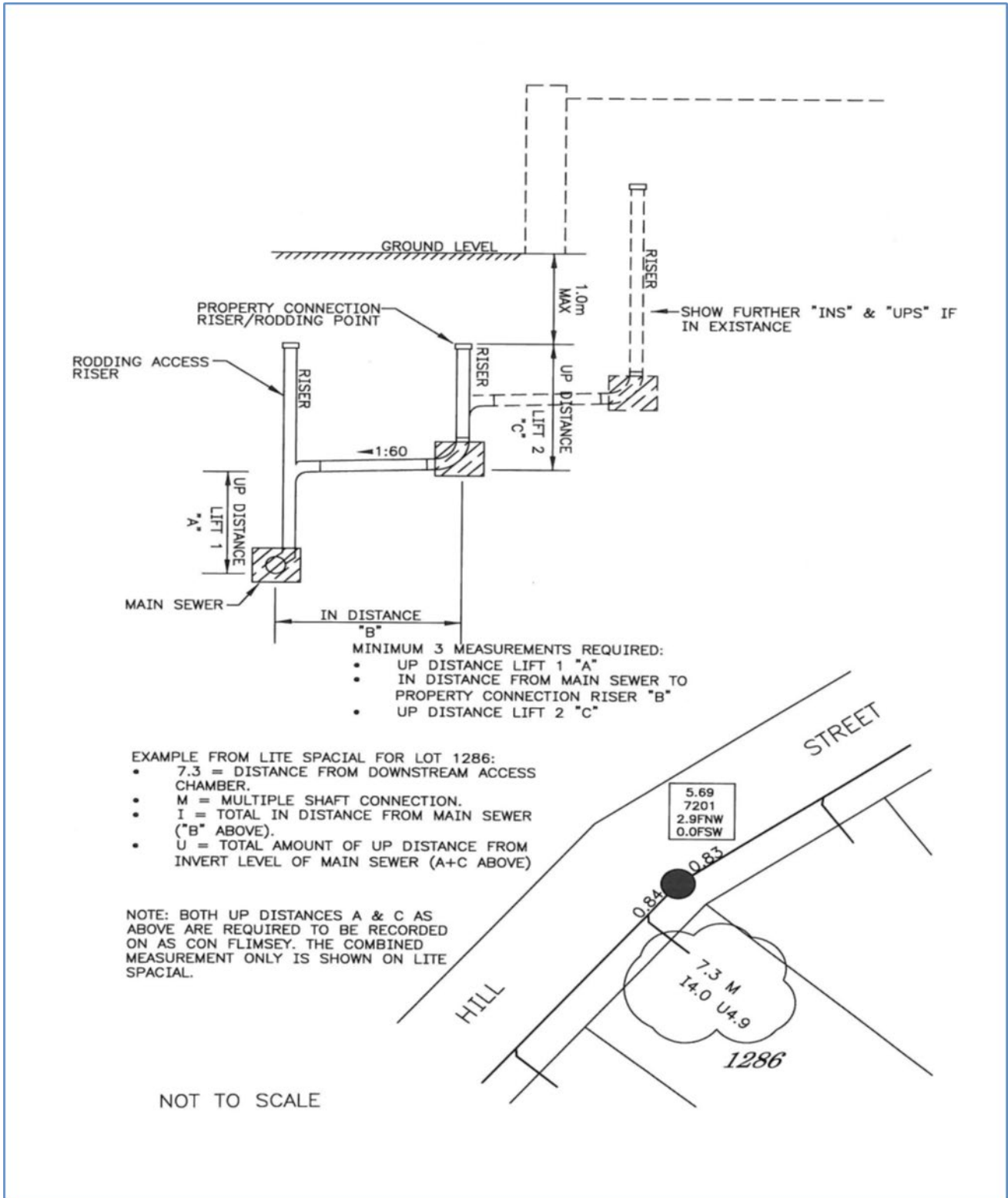





## 2 Guide for measuring property junctions and inspection shafts

### 1.3. Sewer in road reserve, access chamber or maintenance shaft.

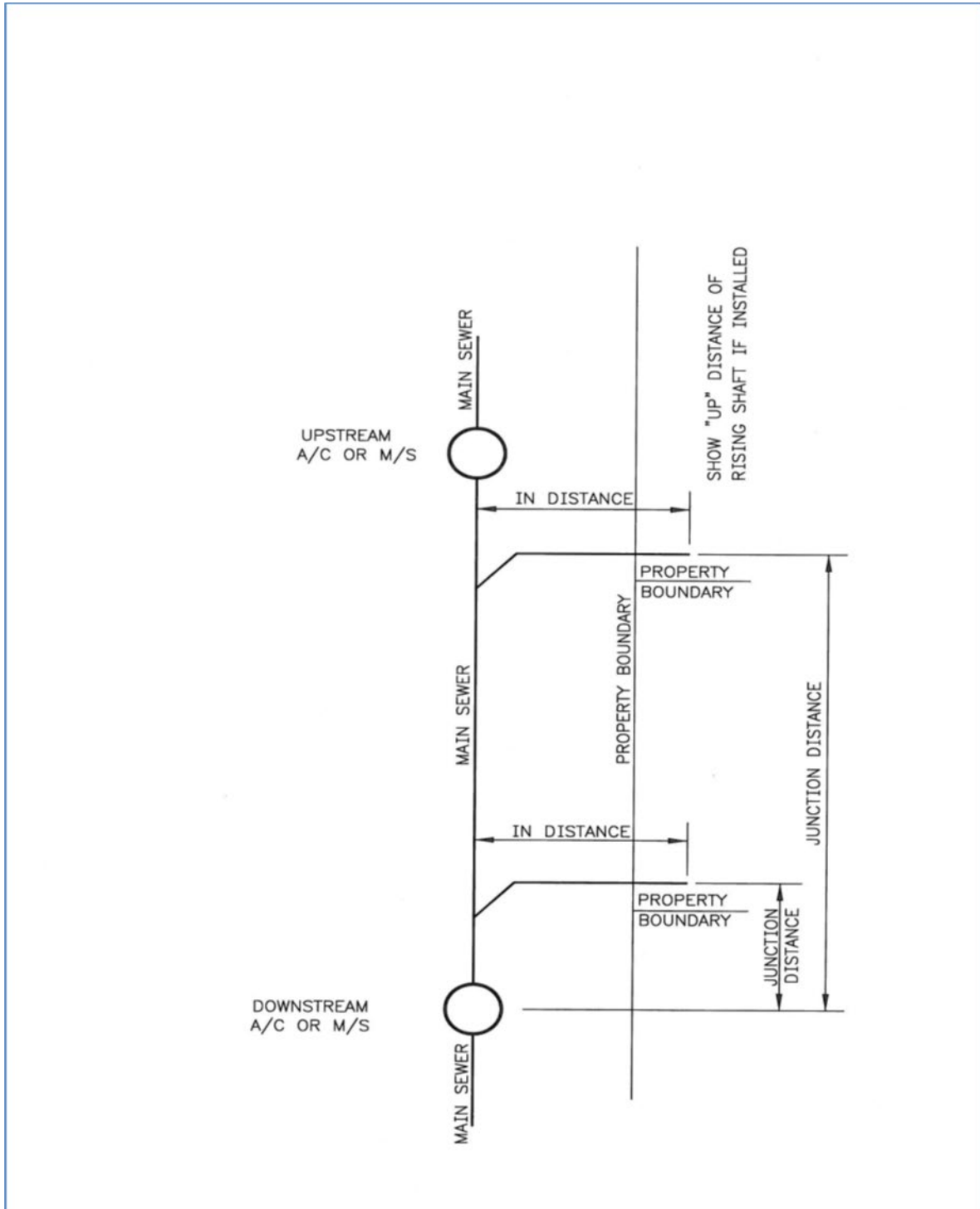



## 2.2 Sewer inside properties access chamber or maintenance shaft

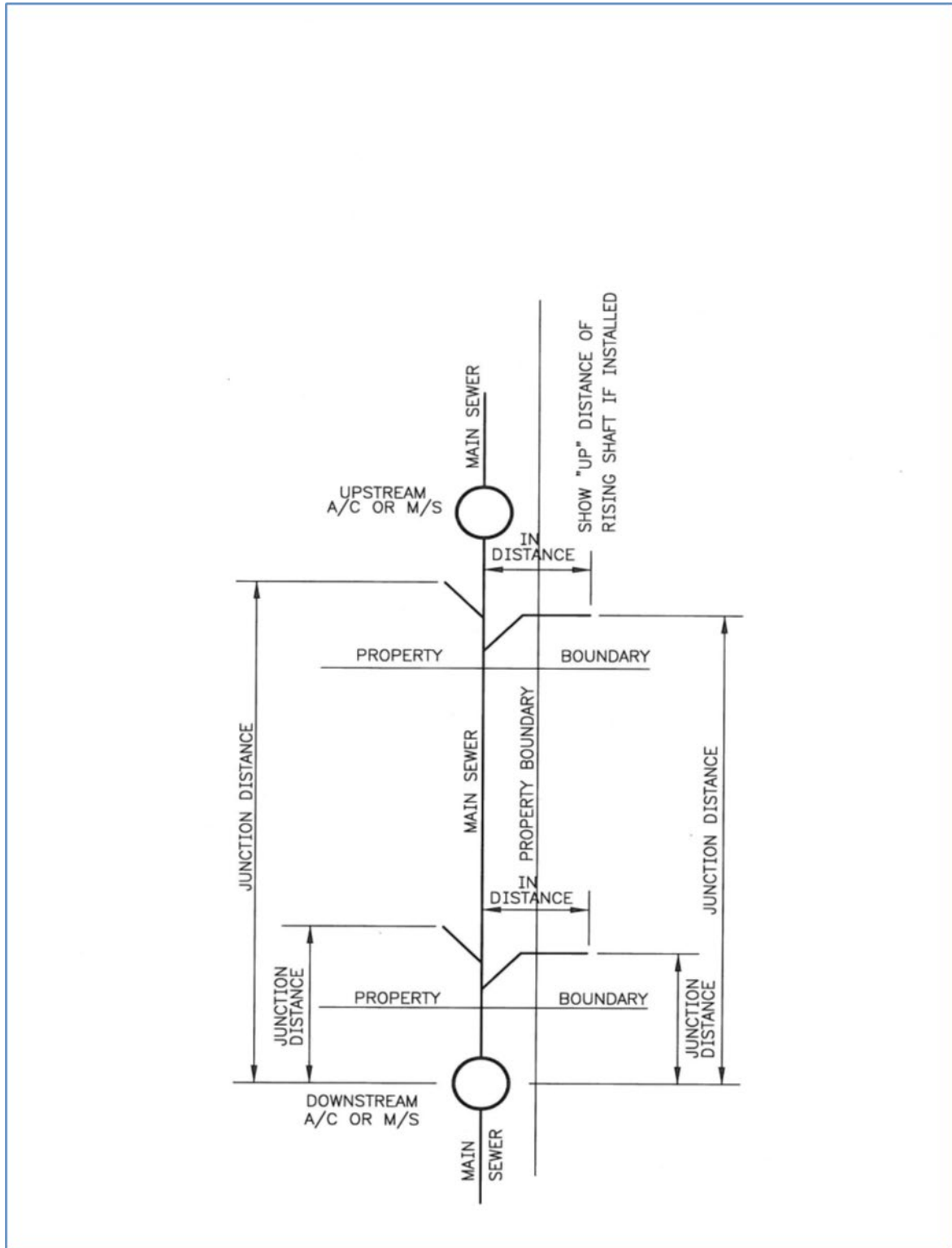



### 2.3 Junction extends past upstream access chamber or maintenance shaft (Scenario 1)

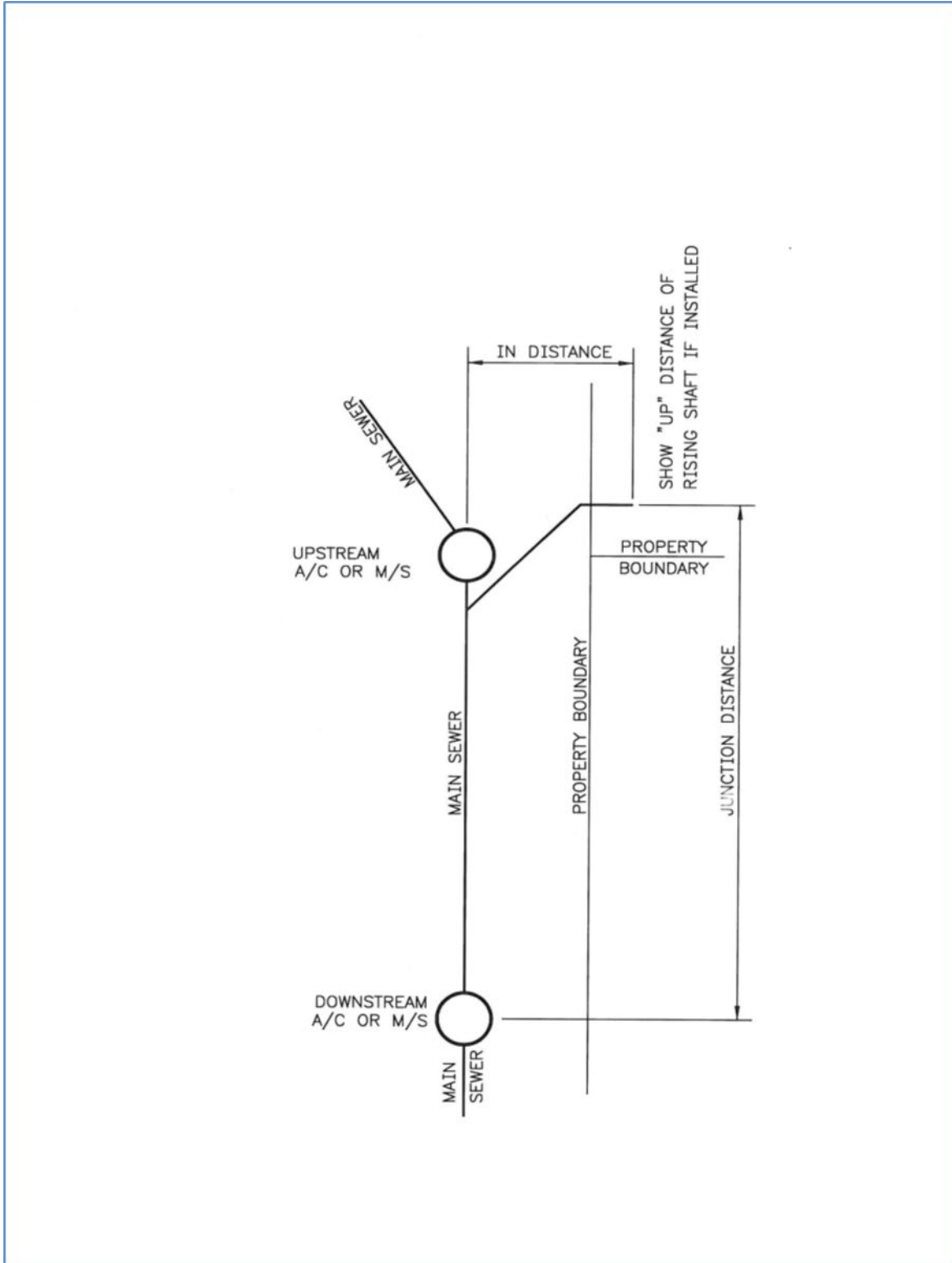



## 2.4 Junction extends past upstream access chamber or maintenance shaft (Scenario 2).

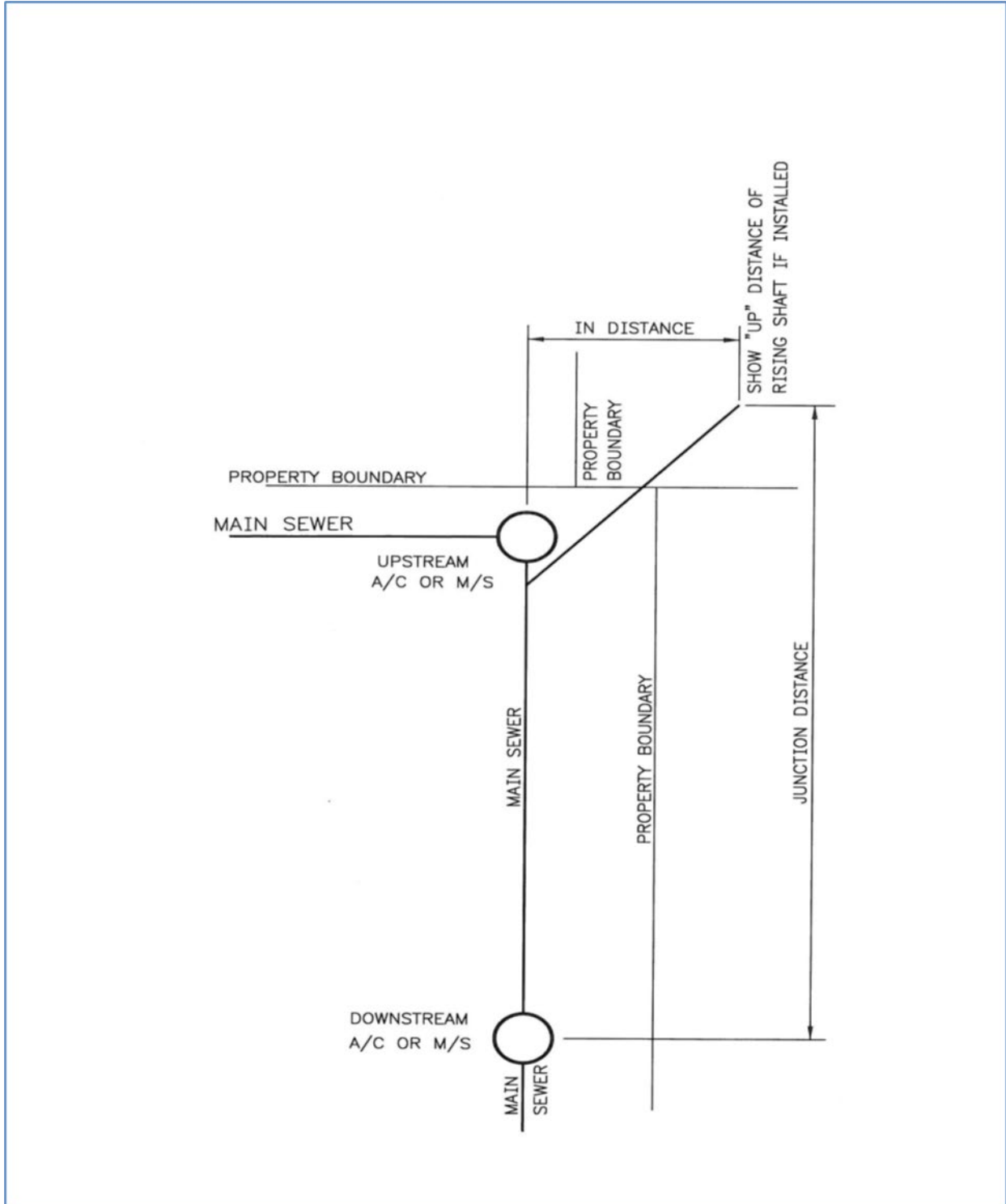



## 2.5 Inspection shaft square to property boundary

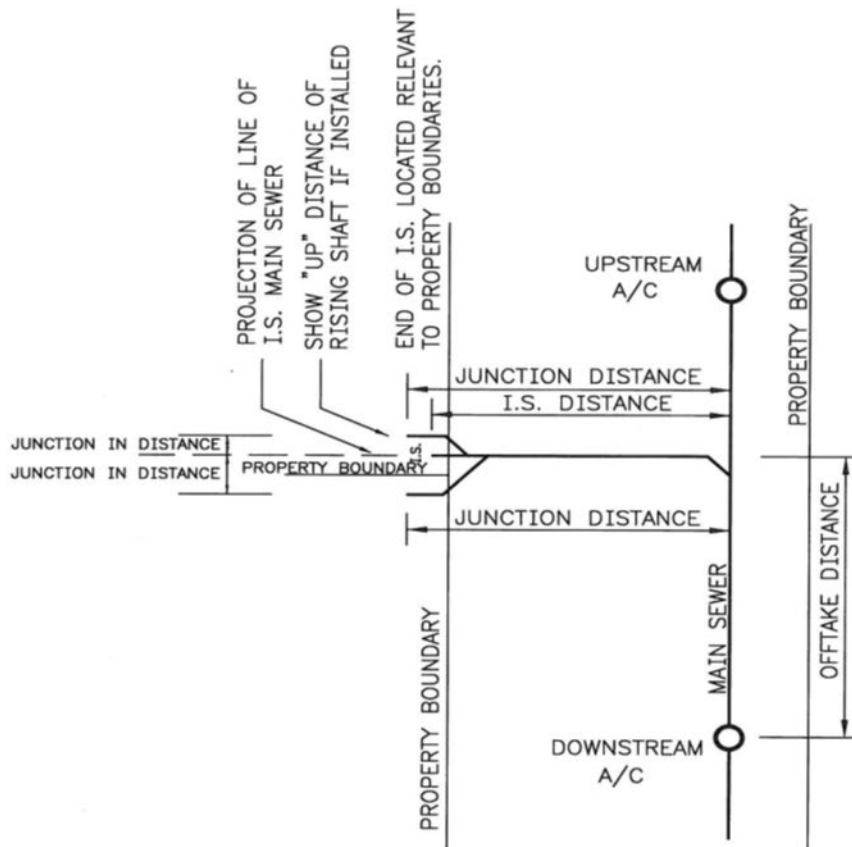



## 2.6 Inspection shaft angled to property boundary

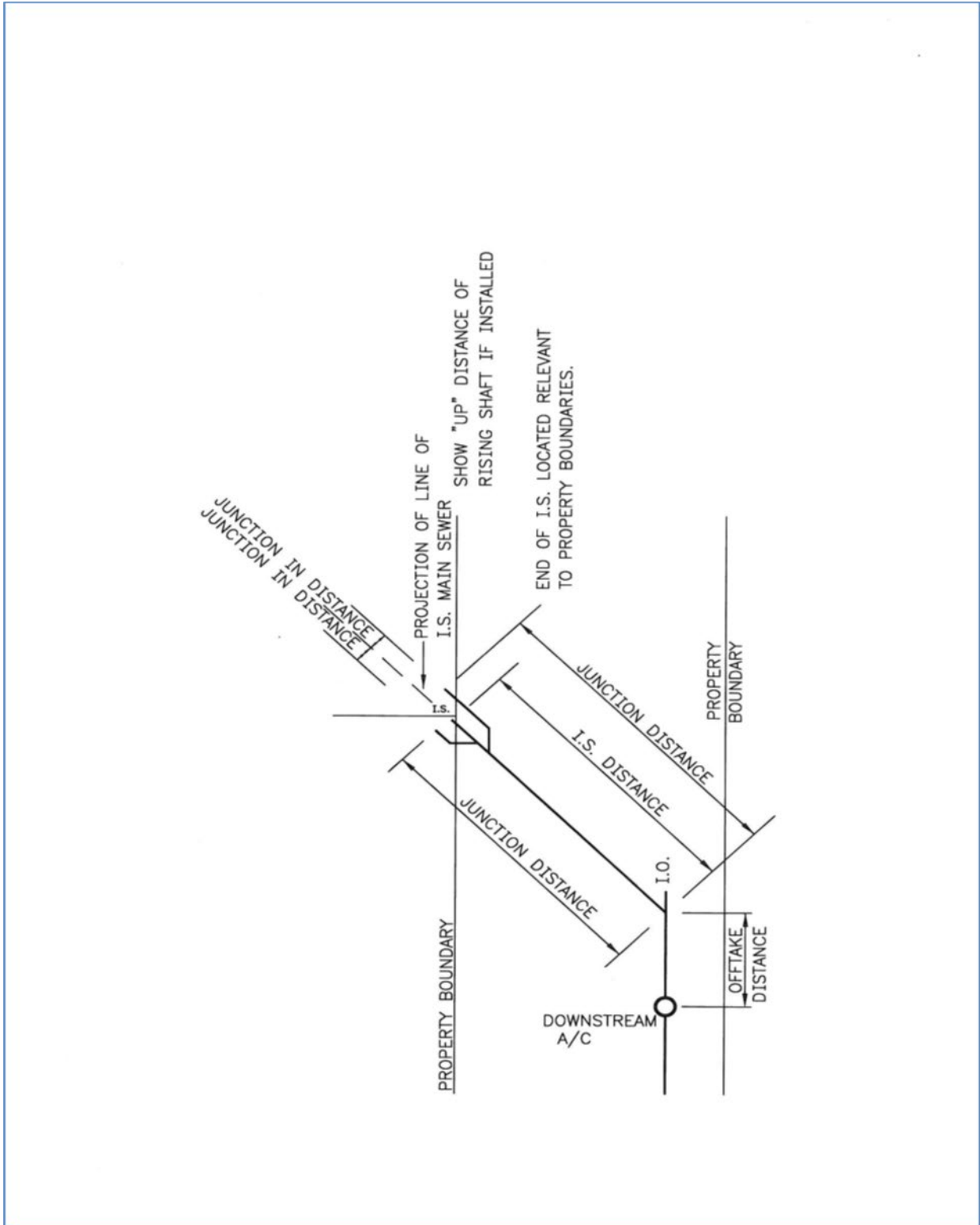





### 3 General Information

#### 3.1 Sewer general layout (access chamber to access chamber)

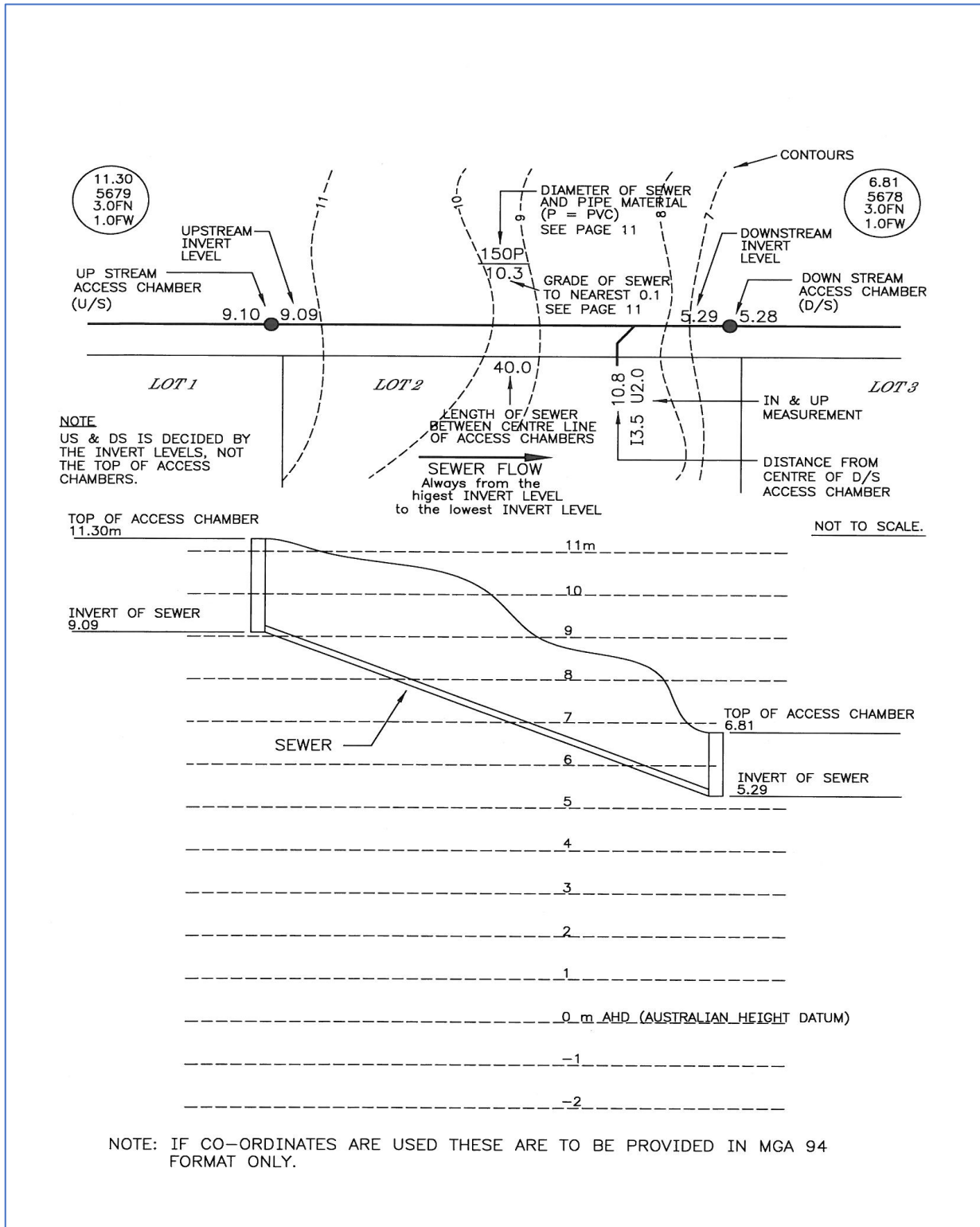



### 3.2 Pipe grade information

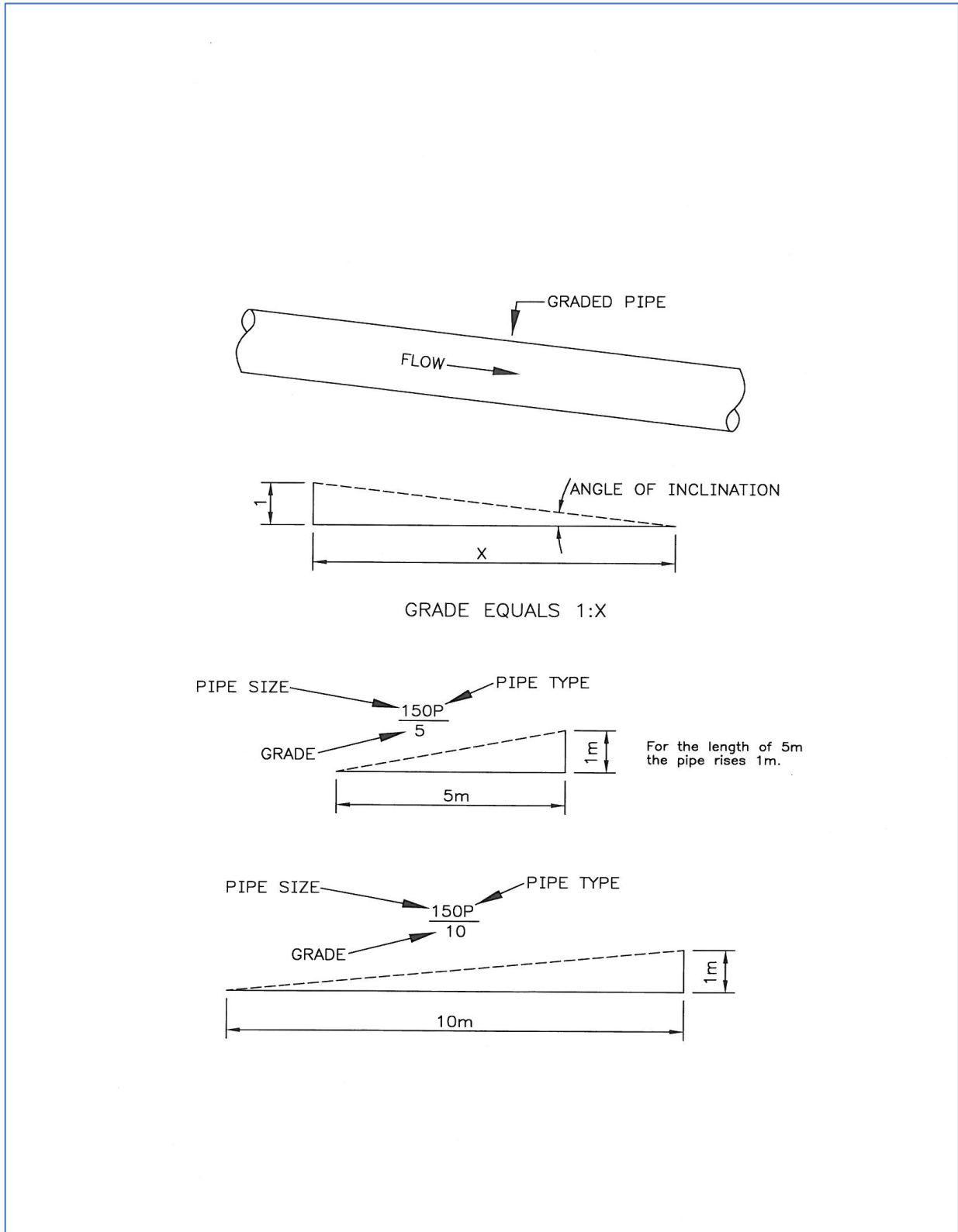



### 3.3 Locating sewers and general information (1).

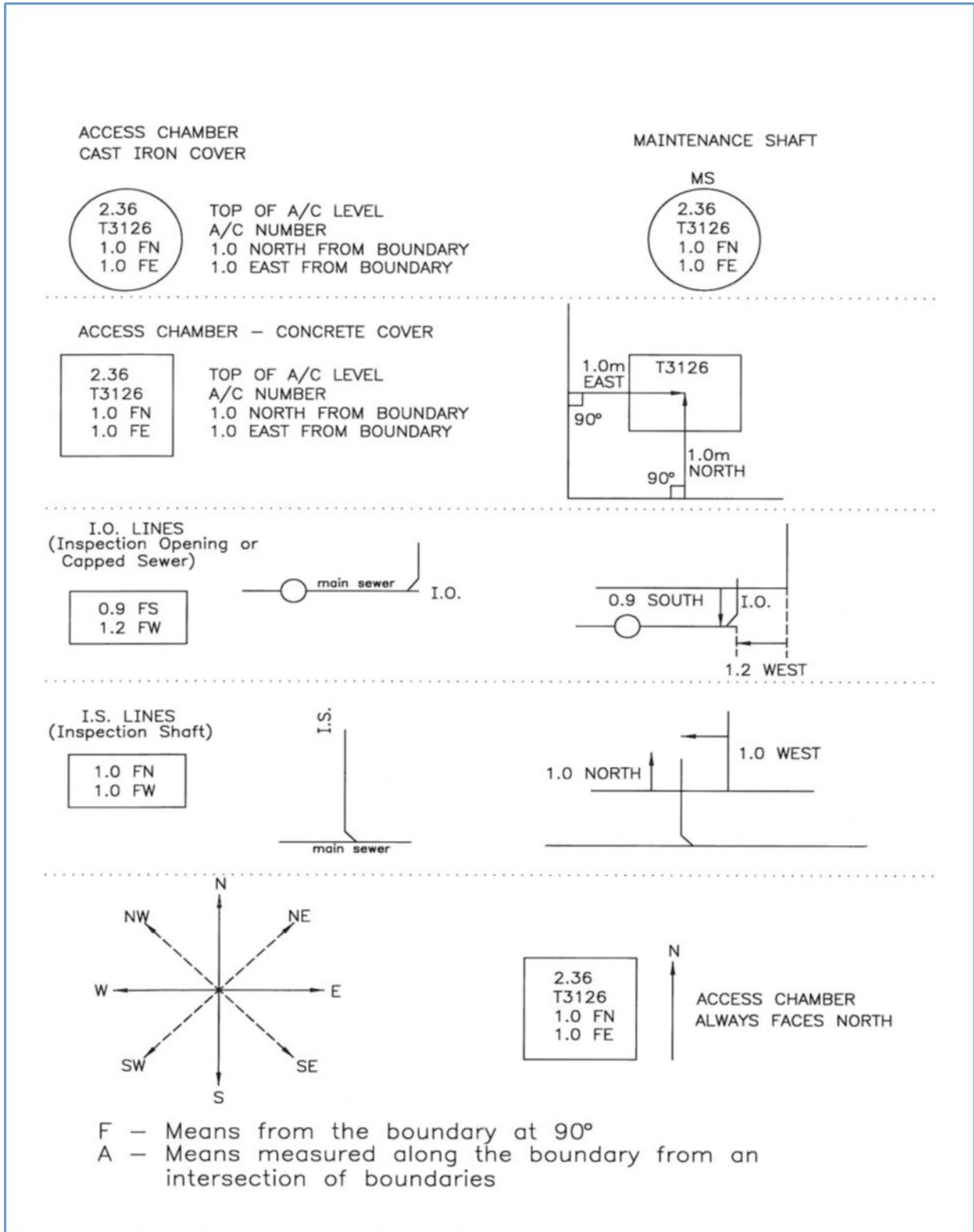



### 3.4 Locating sewers and general information (2).

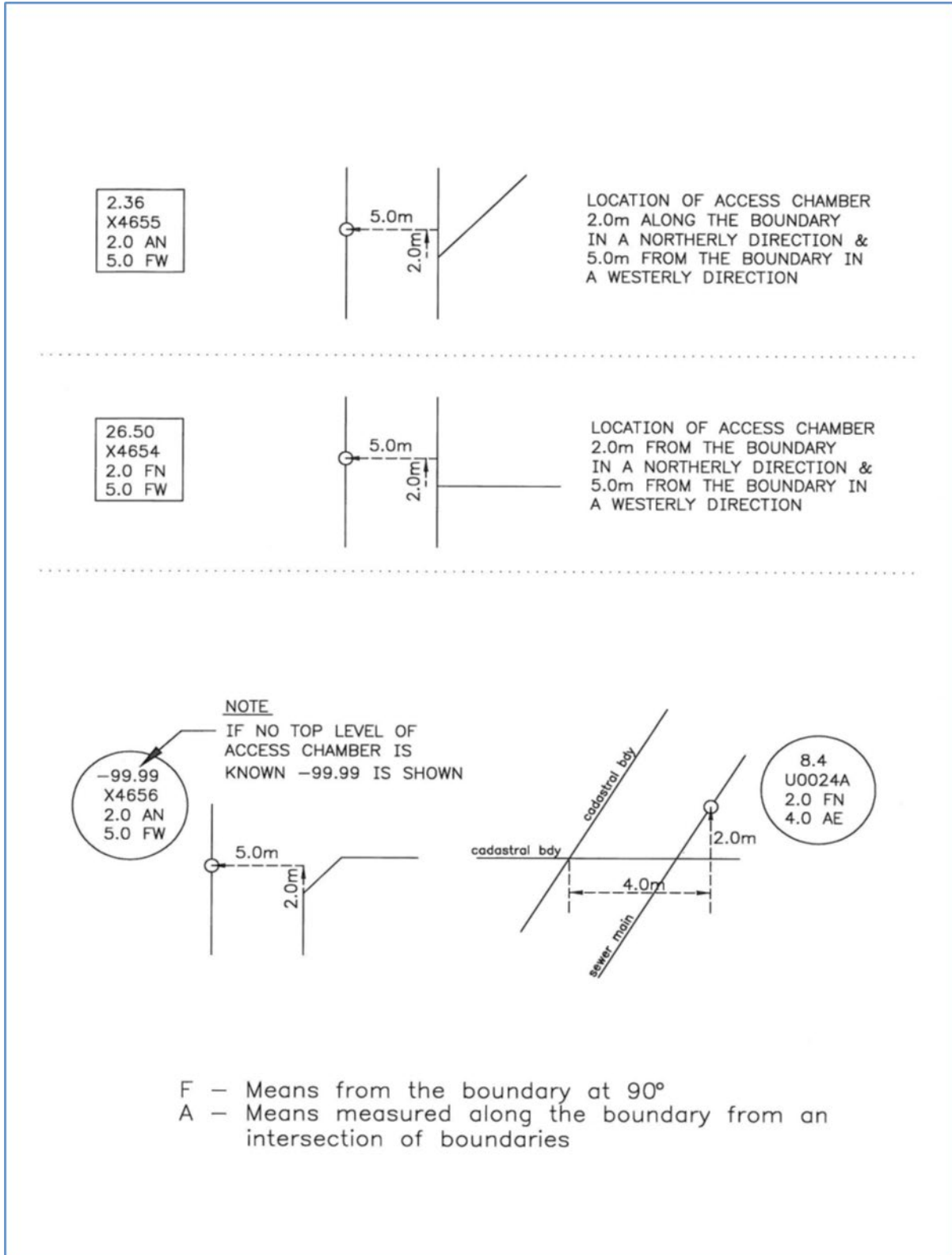



### 3.5 Locate inspection shaft.

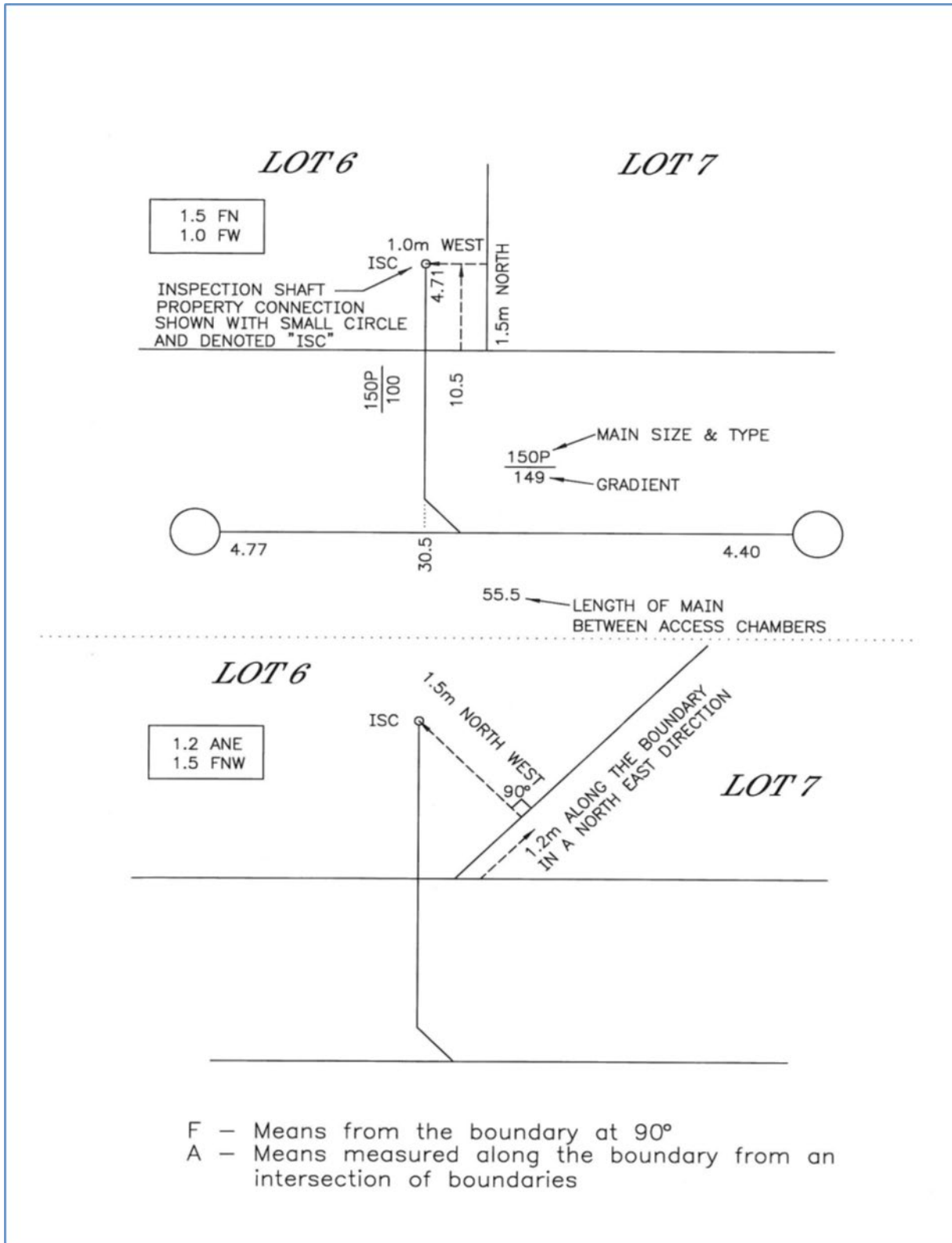



### 3.6 Junction location (Example 1)

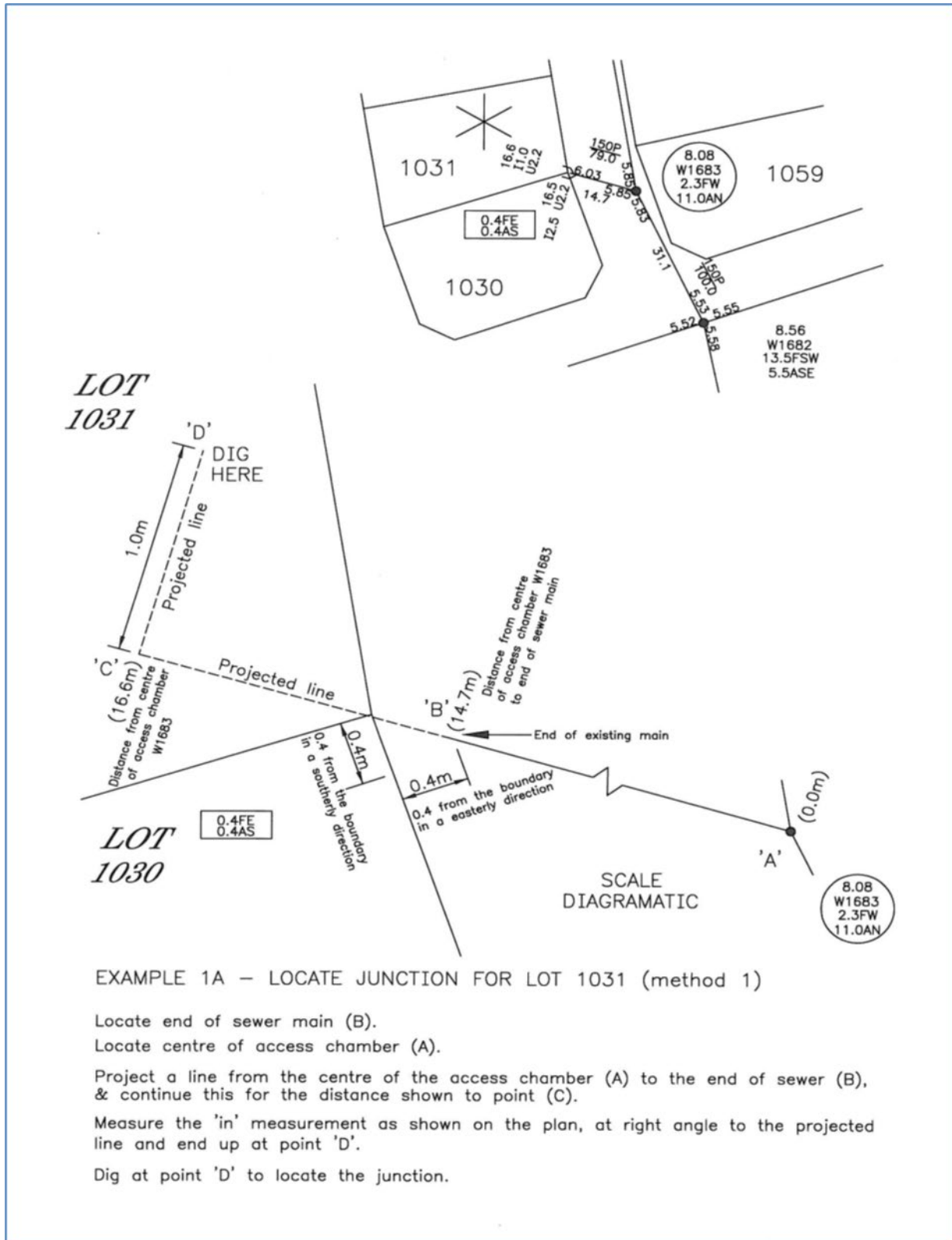





### 3.7 Junction location (Example 2)

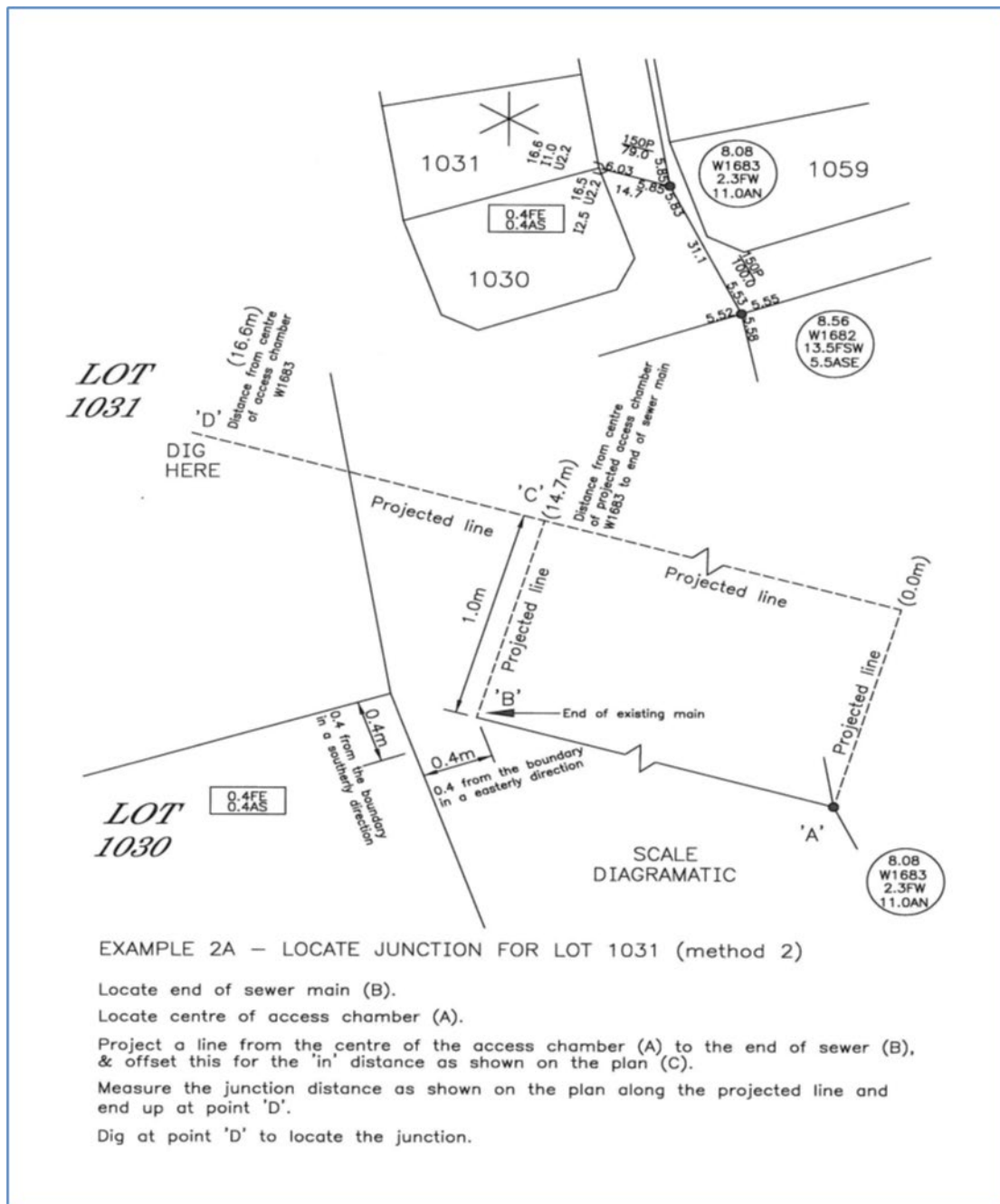



### 3.8 Calculation of sewer grades (1)

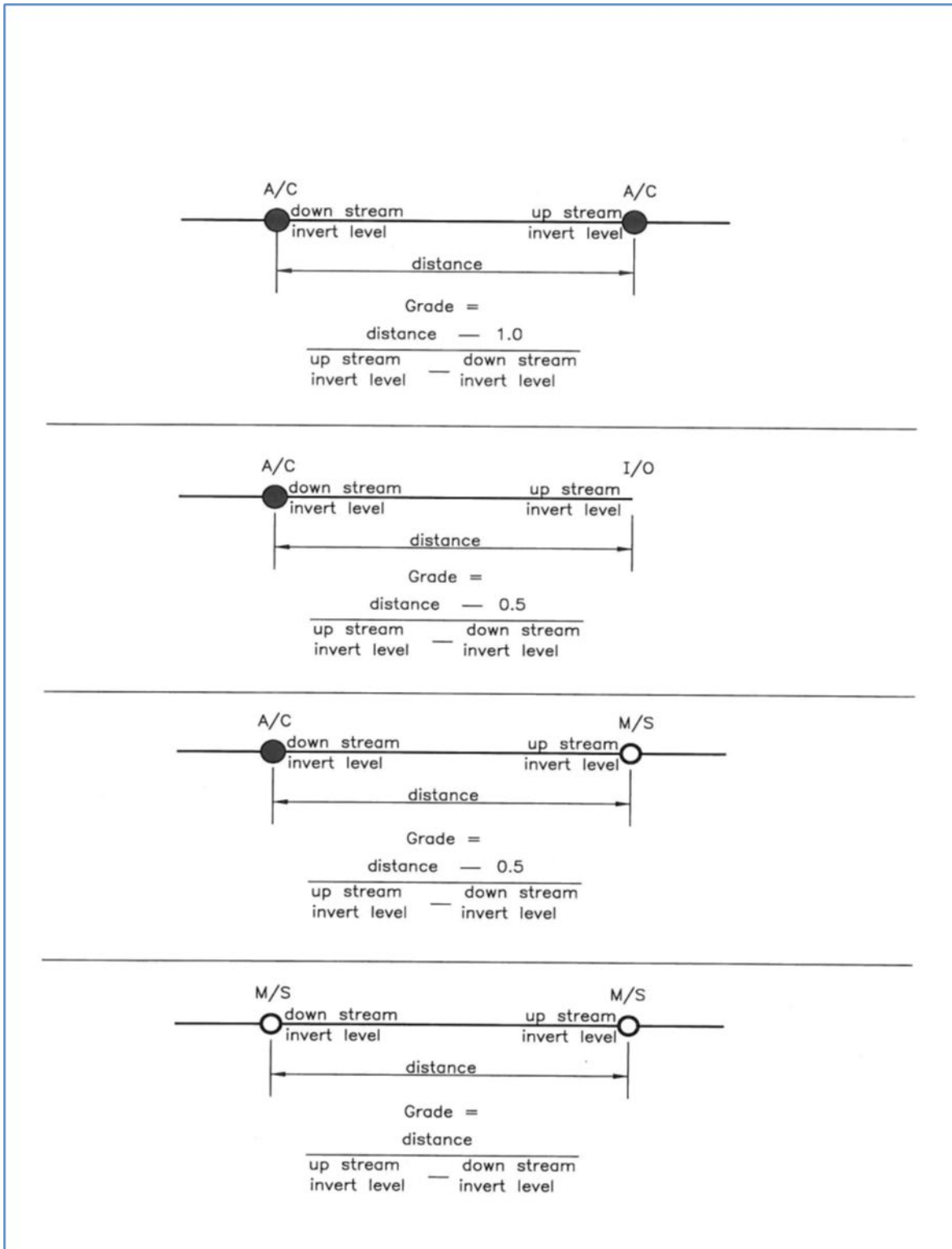



### 3.9 Calculation of sewer grades (2)

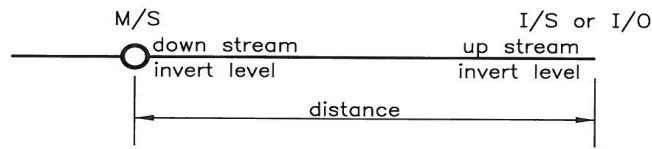

$$\text{Grade} = \frac{\text{up stream invert level} - \text{down stream invert level}}{\text{distance}}$$

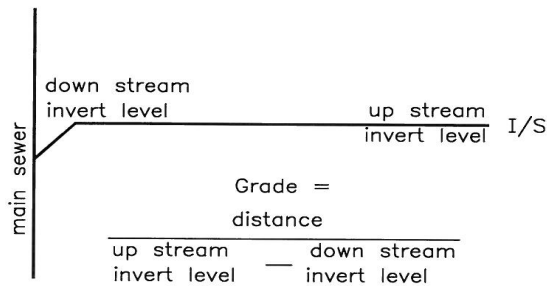

$$\text{Grade} = \frac{\text{up stream invert level} - \text{down stream invert level}}{\text{distance}}$$

Note: Grades are quoted to the nearest 0.1 of a metre.

#### COMMON PIPE TYPES

- P = PVC
- GRP = GLASS REINFORCED PLASTIC
- RC = REINFORCED CONCRETE
- AC = ASBESTOS CEMENT (NO LONGER USED)
- VC = VITREOUS CLAY



## 4 Revisions

The following clauses in this manual were revised on the dates shown.

Revision Number	Issue Date	Reason for Change
1.0	24 February 2012	Initial Issue
1.1	5 March 2014	Hyperlinks reinstated (pages 3 and 4)
1.2	21 October 2016	Updated and corrected information as necessary.
1.3	7 May 2024	Updated to a new template and updated hyperlinks