



Assets Planning and Delivery Group  
Engineering

## **DESIGN STANDARD DS 29**

---

### **Arc Flash Hazard Assessment of Switchgear Assemblies**

---

VERSION 1  
REVISION 6

NOVEMBER 2023

## FOREWORD

The intent of Design Standards is to specify requirements that assure effective design and delivery of fit for purpose Water Corporation infrastructure assets for best whole-of-life value with least risk to Corporation service standards and safety. Design standards are also intended to promote uniformity of approach by asset designers, drafters and constructors to the design, construction, commissioning and delivery of water infrastructure and to the compatibility of new infrastructure with existing like infrastructure.

Design Standards draw on the asset design, management and field operational experience gained and documented by the Corporation and by the water industry generally over time. They are intended for application by Corporation staff, designers, constructors and land developers to the planning, design, construction and commissioning of Corporation infrastructure including water services provided by land developers for takeover by the Corporation.

Nothing in this Design Standard diminishes the responsibility of designers and constructors for applying the requirements of the Western Australia's Work Health and Safety (General) Regulations 2022 to the delivery of Corporation assets. Information on these statutory requirements may be viewed at the following web site location:

[Overview of Western Australia's Work Health and Safety \(General\) Regulations 2022 \(dmirs.wa.gov.au\)](https://dmirs.wa.gov.au)

Enquiries relating to the technical content of a Design Standard should be directed to the Senior Principal Engineer - Electrical, Engineering. Future Design Standard changes, if any, will be issued to registered Design Standard users as and when published.

### Head of Engineering

*This document is prepared without the assumption of a duty of care by the Water Corporation. The document is not intended to be nor should it be relied on as a substitute for professional engineering design expertise or any other professional advice.*

*It is the responsibility of the user to ensure they are using the current version of this document.*

© Copyright – Water Corporation: This standard and software is copyright. With the exception of use permitted by the Copyright Act 1968, no part may be reproduced without the written permission of the Water Corporation.

---

## DISCLAIMER

Water Corporation accepts no liability for any loss or damage that arises from anything in the Standards/Specifications including any loss or damage that may arise due to the errors and omissions of any person. Any person or entity which relies upon the Standards/Specifications from the Water Corporation website does so that their own risk and without any right of recourse to the Water Corporation, including, but not limited to, using the Standards/Specification for works other than for or on behalf of the Water Corporation.

The Water Corporation shall not be responsible, nor liable, to any person or entity for any loss or damage suffered as a consequence of the unlawful use of, or reference to, the Standards/Specifications, including but not limited to the use of any part of the Standards/Specification without first obtaining prior express written permission from the CEO of the Water Corporation.

Any interpretation of anything in the Standards/Specifications that deviates from specific Water Corporation Project requirements must be referred to, and resolved by, reference to and for determination by the Water Corporation's project manager and/or designer for that particular Project.

## REVISION STATUS

The revision status of this standard is shown section by section below.

| REVISION STATUS |           |            |               |   |       |       |
|-----------------|-----------|------------|---------------|---|-------|-------|
| SECT.           | VER./REV. | DATE       | PAGES REVISED | REVISION DESCRIPTION<br>(Section, Clause, Sub-Clause)   | RVWD. | APRV. |
| All             | 1/0       | 18/07/16   | All           | New   | NHJ   | MSP   |
| All             | 1/6       | 17/11/2023 | N/A           | Scheduled review, no changes required to be reviewed in 3 years   | EDG   | EDG   |
| 1               | 1/1       | 16/01/18   | 8             | Sec 1.1 revised   | NHJ   | MSP   |
| 1               | 1/4       | 15/01/2020 | 8             | 1.1 revised   | EDG   | NHJ   |
| 3               | 1/1       | 16/01/18   | 11            | Sec 3 revised   | NHJ   | MSP   |
| 3               | 1/4       | 15/01/2020 | 12            | Sec 3 revised   | EDG   | NHJ   |
| 4               | 1/1       | 16/01/18   | 12            | Sec 4 revised   | NHJ   | MSP   |
| 7               | 1/1       | 16/01/18   | 28, 31        | Table 7 revised<br>Sec 7.1, 7.4 revised   | NHJ   | MSP   |
| 6               | 1/4       | 15/01/2020 | 14-27         | Clause 6.5.2 modified   | EDG   | NHJ   |
| 8               | 1/1       | 16/01/18   | 31-33         | Sec 8 revised   | NHJ   | MSP   |
| 9               | 1/1       | 16/01/18   | 34            | Sec 9 revised;<br>Table 8 renamed Table 8a and revised;<br>Table 8b new;<br>Table 9 renamed Table 9a and revised;<br>Table 9b new | NHJ   | MSP   |
| 10              | 1/1       | 16/01/18   | 41-43         | Sec 10, 10.5, 10.8 revised  | NHJ   | MSP   |
| 11              | 1/1       | 16/01/18   | 44            | Sec 11 revised  | NHJ   | MSP   |
| 13              | 1/1       | 16/01/18   | 47-70         | Figure 15 and 17 revised;<br>Sec 13.1.3.1, 13.2.1 revised   | NHJ   | MSP   |
| All             | 1/3       | 08/10/2019 | 8-84          | Whole document reviewed   | EDG   | NHJ   |
| 14              | 1/4       | 15/01/2020 | 83-84         | Clause 14 (AppendixB) added   | EDG   | NHJ   |
| 15              | 1/5       | 09/10/2020 |               | Clause 15 (Appendix B) added  | EDG   | NHJ   |

# DESIGN STANDARD DS 29

## Arc Flash Hazard Assessment of Switchgear Assemblies

### CONTENTS

| <i>Section</i> |  | <i>Page</i> |
|----------------|--|-------------|
| <b>1</b>       | <b>INTRODUCTION .....</b>                                      | <b>8</b>    |
| <b>1.1</b>     | <b>Purpose.....</b>  | <b>8</b>    |
| <b>1.2</b>     | <b>Scope.....</b>  | <b>8</b>    |
| <b>1.3</b>     | <b>Modelling Software .....</b>                                | <b>9</b>    |
| <b>1.4</b>     | <b>High Level Process Flow Chart .....</b>                     | <b>9</b>    |
| <b>2</b>       | <b>REFERENCES .....</b>  | <b>10</b>   |
| <b>2.1</b>     | <b>Design Manuals .....</b>                                    | <b>10</b>   |
| <b>2.2</b>     | <b>Acts .....</b>  | <b>11</b>   |
| <b>2.3</b>     | <b>Australian Standards .....</b>                              | <b>11</b>   |
| <b>2.4</b>     | <b>International Standards .....</b>                           | <b>11</b>   |
| <b>3</b>       | <b>TERMS AND DEFINITIONS.....</b>                              | <b>11</b>   |
| <b>4</b>       | <b>MANDATORY REQUIREMENTS .....</b>                            | <b>12</b>   |
| <b>5</b>       | <b>BACKGROUND .....</b>  | <b>12</b>   |
| <b>5.1</b>     | <b>Definition of an Arc Flash .....</b>                        | <b>12</b>   |
| <b>5.2</b>     | <b>Consequences of an Arc Flash .....</b>                      | <b>13</b>   |
| <b>5.3</b>     | <b>Goals of an Arc Flash Incident Energy Assessment .....</b>  | <b>13</b>   |
| <b>5.4</b>     | <b>Standards and Available Tools.....</b>                      | <b>14</b>   |
| <b>6</b>       | <b>PERFORMING ARC FLASH ASSESSMENTS .....</b>                  | <b>14</b>   |
| <b>6.1</b>     | <b>Outcomes of an IEEE Std 1584/Lee Method Assessment.....</b> | <b>14</b>   |
| 6.1.1          | Incident Energy at the Working Distance .....                  | 15          |
| 6.1.2          | Arc Flash Boundary (Closest Approach Distance).....            | 15          |
| 6.1.3          | Hazard Rating Category.....                                    | 15          |
| <b>6.2</b>     | <b>Assessment Process .....</b>                                | <b>15</b>   |
| <b>6.3</b>     | <b>Assessment Scenarios .....</b>                              | <b>15</b>   |
| <b>6.4</b>     | <b>Arc Flash Assessment Overview – Steps.....</b>              | <b>16</b>   |
| <b>6.5</b>     | <b>Collecting the System and Installation Data.....</b>        | <b>17</b>   |
| 6.5.1          | Utility Fault Contribution .....                               | 17          |
| 6.5.2          | Generators.....  | 17          |
| 6.5.3          | Transformers.....  | 18          |
| 6.5.4          | Cables .....   | 18          |
| 6.5.5          | Protection Device Characteristics.....                         | 18          |
| 6.5.6          | Switching Points .....   | 19          |
| 6.5.7          | Loads.....   | 19          |

---

|             |   |           |
|-------------|---|-----------|
| 6.5.8       | System Busses .....   | 20        |
| <b>6.6</b>  | <b>Preparing a Software Model of the Electrical System .....</b>      | <b>20</b> |
| <b>6.7</b>  | <b>Determine the Bolted Fault Current .....</b>                       | <b>20</b> |
| 6.7.1       | Determining the System Modes of Operation .....                       | 20        |
| 6.7.2       | Calculating Maximum and Minimum Three Phase Bolted Fault Levels ..... | 20        |
| <b>6.8</b>  | <b>Determining Bus Gaps.....</b>                                      | <b>22</b> |
| <b>6.9</b>  | <b>Converting Bolted Fault Currents to Arcing Fault Currents.....</b> | <b>23</b> |
| 6.9.1       | Identifying arc fault current contributing branches .....             | 23        |
| 6.9.2       | Identifying Induction Motor Contributions .....                       | 24        |
| <b>6.10</b> | <b>Assessing the Duration of the Arcing Fault.....</b>                | <b>24</b> |
| <b>6.11</b> | <b>Determining Working Distances .....</b>                            | <b>25</b> |
| <b>6.12</b> | <b>Determining the Incident Energy at the Working Distance.....</b>   | <b>25</b> |
| <b>6.13</b> | <b>Determining ‘Worst Case’ Incident Energy .....</b>                 | <b>26</b> |
| <b>6.14</b> | <b>Determining the Arc Flash Boundary .....</b>                       | <b>27</b> |
| <b>7</b>    | <b>DETERMINING THE REQUIRED PPE LEVEL .....</b>                       | <b>28</b> |
| 7.1         | Arc Rated PPE Selection.....  | 28        |
| 7.2         | Internal Arc Rating.....  | 30        |
| 7.3         | Doors Open or Closed .....  | 30        |
| 7.4         | Operational activities .....  | 30        |
| <b>8</b>    | <b>PRODUCING ARC FLASH WARNING LABELS .....</b>                       | <b>31</b> |
| <b>9</b>    | <b>WHERE INCIDENT ENERGY CALCULATIONS ARE NOT REQUIRED .....</b>      | <b>35</b> |
| <b>10</b>   | <b>Arc Flash Mitigation .....</b>                                     | <b>42</b> |
| 10.1        | Protection Device Selection and Setting Optimisation.....             | 42        |
| 10.2        | Protection device specification.....                                  | 43        |
| 10.3        | Switchboard Design Considerations .....                               | 43        |
| 10.4        | Arc Fault Current Limiting .....                                      | 43        |
| 10.5        | Arc Flash Detection .....   | 43        |
| 10.6        | Arc Quenching.....  | 44        |
| 10.7        | Zone Selective Interlocking.....                                      | 44        |
| 10.8        | Remote Switching .....  | 45        |
| <b>11</b>   | <b>Documenting Assessment Results and Deliverables .....</b>          | <b>45</b> |
| <b>12</b>   | <b>Change Control.....</b>  | <b>46</b> |
| <b>13</b>   | <b>Appendix A – HV and LV Worked Examples.....</b>                    | <b>46</b> |
| <b>13.1</b> | <b>Large installation.....</b>  | <b>47</b> |
| 13.1.1      | Model Development and Bolted Fault Calculations .....                 | 48        |
| 13.1.2      | Low Voltage MCC .....   | 54        |
| 13.1.3      | High Voltage 22kV Switchboard.....                                    | 62        |
| 13.1.4      | Power*Tools Software Example .....                                    | 66        |

---

|             |   |           |
|-------------|---|-----------|
| <b>13.2</b> | <b>Small installation</b> .....   | <b>69</b> |
| 13.2.1      | Table-based approach.....   | 70        |
| 13.2.2      | Calculation-based approach.....   | 72        |
| <b>13.3</b> | <b>Constant Clearing Time Curves</b> .....  | <b>73</b> |
| <b>13.4</b> | <b>Maximum Corresponding Arc Fault Currents</b> .....                             | <b>77</b> |
| <b>13.5</b> | <b>Example for Stage 3 Assessment</b> .....                                       | <b>77</b> |
| <b>13.6</b> | <b>Lineside and Busbar Energy Reduction Process</b> .....                         | <b>80</b> |
| <b>14</b>   | <b>Appendix B – Arc Flash Hazard Rated Category of Temporary Generators</b> ..... | <b>82</b> |
| <b>15</b>   | <b>Appendix C – DC Arc Flash Assessment</b> .....                                 | <b>84</b> |
| <b>15.1</b> | <b>DC Arc Flash Assessment Overview</b> .....                                     | <b>84</b> |
| <b>15.2</b> | <b>Outcomes of a DC Arc Flash Assessment</b> .....                                | <b>84</b> |
| <b>15.3</b> | <b>Assessment Scenarios</b> .....   | <b>84</b> |
| <b>15.4</b> | <b>DC Arc Flash Assessment Overview – Steps</b> .....                             | <b>85</b> |
| 15.4.1      | Collect the system and equipment data.....  | 86        |
| 15.4.2      | Determine the bolted fault current and DC source resistance .....                 | 87        |
| 15.4.3      | Determine the arc gap .....   | 87        |
| 15.4.4      | Calculate the arc fault resistance and arc fault current .....                    | 87        |
| 15.4.5      | Assess the duration of the arcing fault.....                                      | 88        |
| 15.4.6      | Determine the working distance.....   | 88        |
| 15.4.7      | Determine the incident energy at the working distance .....                       | 88        |
| 15.4.8      | Determine the arc flash boundary.....   | 89        |
| <b>15.5</b> | <b>15.5 Selecting PPE</b> .....   | <b>90</b> |
| <b>15.6</b> | <b>Arc Flash Warning Labels</b> .....   | <b>90</b> |
| <b>15.7</b> | <b>Where DC Incident Energy Calculations are not Required</b> .....               | <b>91</b> |
| <b>15.8</b> | <b>DC Arc Flash Mitigation</b> .....  | <b>91</b> |
| <b>15.9</b> | <b>DC Arc Flash Example Calculations</b> .....                                    | <b>94</b> |

---

# 1 INTRODUCTION

## 1.1 Purpose

The Water Corporation has adopted a policy of outsourcing most of the electrical engineering and electrical detail design associated with the procurement of its assets. The resulting assets need to be in accordance with the Corporation's operational needs and standard practices.

It is the Water Corporation's objective that its assets will be designed so that they are safe, have a minimum long term cost and are convenient to operate and maintain. In respect to matters not covered specifically in this manual, the Designer shall aim their designs and specifications at achieving this objective.

This design standard, Electrical Design Standard DS29, sets out design standards and engineering practice which shall be followed in respect of the analysis, mitigation and documentation of arc flash hazards on power electrical equipment acquired by the Water Corporation.

This includes:

- HV and LV switchboard assemblies
- Power equipment switchgear and assemblies
- Variable speed drive assemblies
- Motor starter assemblies
- Backup generator fed assemblies
- Power factor correction unit assemblies
- Harmonic filter assemblies
- Any other cubicle assemblies containing LV or HV primary power circuits
- DC Systems

Control, instrumentation and SCADA cubicles do not require arc flash analysis or categorisation.

The primary intent is to protect personnel from potential injury by an arc flash hazard, by preventing arc flash exposure. This standard is intended to ensure that consistent arc flash outcomes are achieved across Water Corporation operations.

This design manual cannot and does not address all issues that will need to be considered by the Designer in respect to a particular arc flash hazard scenario.

This design standard is intended for the guidance and direction of electrical system designers and shall not be quoted in specifications (including drawings) for the purpose of purchasing electrical equipment or electrical installations except as part of the prime specification for a major Design and Construct (D&C) contract.

## 1.2 Scope

This standard defines the accepted Water Corporation's practices for arc flash incident energy assessments, arc rated personal protective equipment, warning label specifications and design safety to reduce arc flash risk for HV and LV electrical switchboards.

The arc flash hazard assessments detailed in this standard shall be undertaken during the engineering design stage and shall be carried out by the Designer.

The standard applies both for the installation of new switchboards and for any changes to an installation affecting the arc flash incident energy levels of an existing switchboard. For example, changing an existing switchboard's feeder or incomer protection, or upgrading the supply transformer, or multiple power supplies (solar, genset, etc.) will affect arc flash incident energy levels and shall be considered in accordance with this standard.



Furthermore, existing switchboards that have not been previously assessed and switchboards required to be periodically reviewed shall be assessed in accordance with this standard.

The following elements are included:

- Performing arc flash incident energy calculations based on either the methods presented in the Institute of Electrical and Electronics Engineers (IEEE) Std 1584 to calculate incident energy levels, the arc flash boundary and the hazard rating category or the short-hand method as per Clause 9
- DC arc models and incident energy calculations – Ammerman (refer Appendix C)
- System study model development (refer Clause 1.3)
- Specifying arc rated PPE requirements taking into consideration the calculated incident energy levels, the switchboard design ratings/test certifications and operational activities
- Producing arc flash warning labels
- Specifying arc flash design safety requirements including switchboard types, protection device types and setting optimisation, remote switching, fault current limiting and arc flash detection equipment

### 1.3 Modelling Software

The SKM Power\*Tools for Windows (PTW) modelling software package shall be used to create power system models and perform arc flash hazard assessments. The use of PTW provides:

- Consistency of approach
- Consistency of output
- High level of confidence
- Accurate modelling
- Common basis for the future switchboard modifications/assessment

### 1.4 High Level Process Flow Chart

An overview of the arc flash assessment process is shown in Figure 1. A detailed explanation of the steps shown in the chart is provided in Section 6 – Section 10.

The ‘worst case’ incident energy, as referred to in the flowchart, reflects the requirement for the arc flash assessments to follow a sensitivity analysis based approach. The ‘worst case’ is determined by undertaking four separate calculations for each assessment location. This approach is required due to variations in the bolted fault levels and the accuracy limits of converting from bolted to arcing fault current, where a slight variation in arcing fault current can lead to a disproportionately large increase in the duration of the arc (refer to Clause 6.13). For simplicity the sensitivity study steps are not shown in Figure 1.

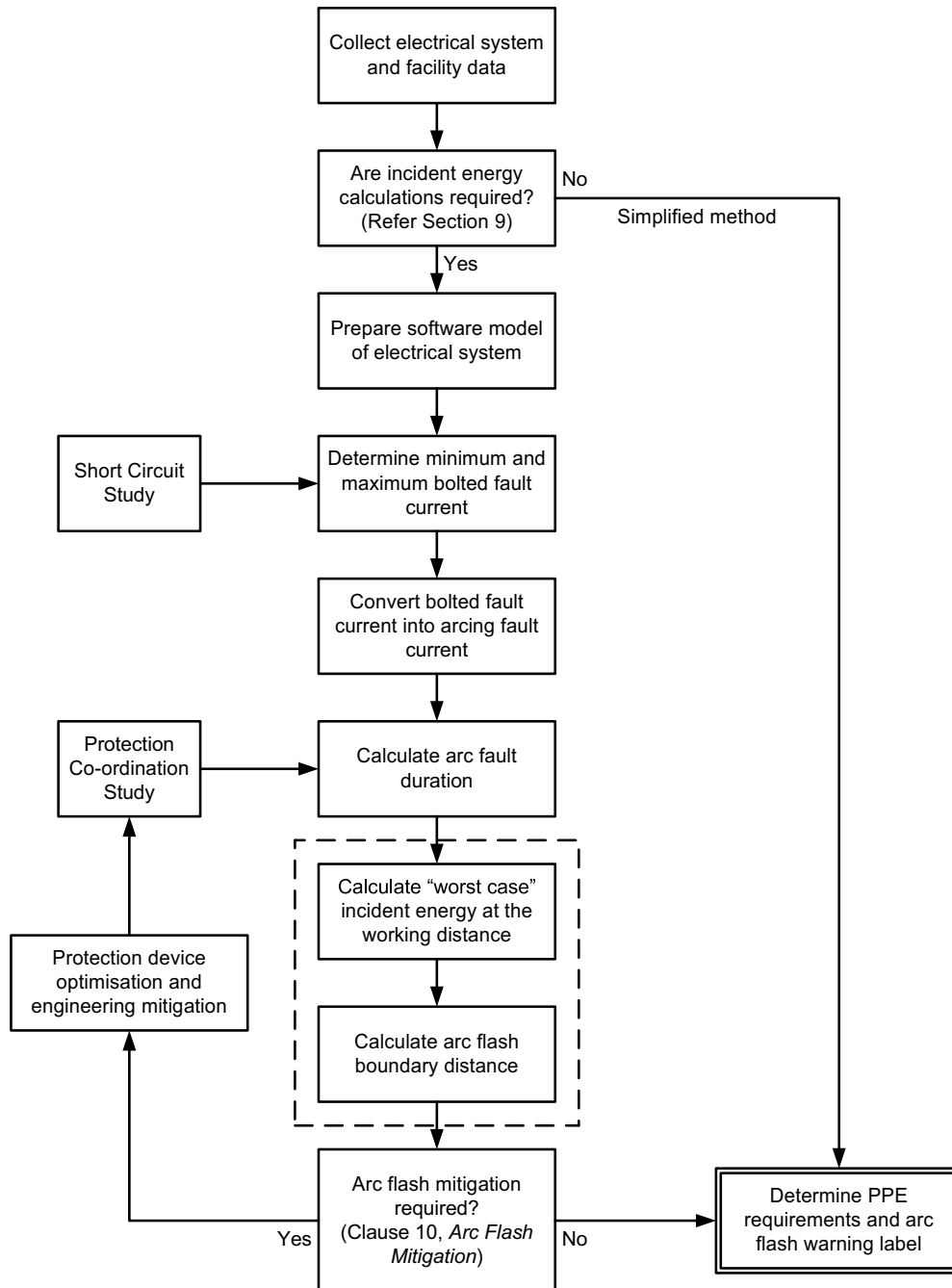

Figure 1: High Level Process Flowchart

## 2 REFERENCES

Reference shall be made also to the following associated Design Manuals, Acts and Standards:

### 2.1 Design Manuals

- DS 20 Design Process for Electrical Works
- DS 21 Major Pump Station – Electrical
- DS 22 Ancillary Plant and Small Pump Stations – Electrical

---

|       |   |
|-------|---|
| DS 26 | Type Specifications – Electrical                    |
| DS 28 | Water and Waste Water Treatment Plants – Electrical |

## 2.2 Acts

Model Work Health and Safety Act  
WA Energy Safety Requirements

## 2.3 Australian Standards

The current version of:

|                 |   |
|-----------------|---|
| AS/NZS 3000     | Electrical Installations – ‘Wiring Rules’   |
| AS/NZS 3008.1.1 | Electrical Installations – Selection of cables – Cables for alternating voltages up to and including 0.6/1 kV       |
| AS 2067         | Substations and High Voltage Installations  |
| AS 3851         | The calculation of short-circuit currents in three phase AC systems   |
| AS 62271.200    | High-voltage switchgear and controlgear - AC metal-enclosed switchgear and controlgear for rated voltages above 1kV |
| AS/NZS 4836     | Safe working on or near low voltage electrical installations and equipment  |
| AS/NZS 61439    | Low-voltage switchgear and controlgear assemblies   |
| AS/NZS 5139     | Electrical installations — Safety of battery systems for use with power conversion equipment                        |

## 2.4 International Standards

The current version of:

|               |   |
|---------------|---|
| IEEE Std 1584 | IEEE Guide for Performing Arc Flash Hazard Calculations |
| NFPA 70E      | Standard for Electrical Safety in the Workplace         |

## 3 TERMS AND DEFINITIONS

**Arc Rated (AR) PPE** – Clothing specified with an ATPV (Arc Thermal Performance Value) expressed in calories per centimetre squared. AR PPE with an ATPV has been specifically tested to provide protection against electrical arcing faults

**Arcing Fault Current** – A fault current flowing through an electrical arc plasma. Also referred to as arc fault current or arc current

**Arc Flash Hazard** – A dangerous condition associated with the possible release of energy caused by an electric arc

**Arc Flash Exposure Consequence** – The assessed potential for an arcing fault to harm people or to damage property in the event of an arc flash event occurring, and is derived from Arc Flash Incident Energy Calculations

**Arc Flash Incident Energy Calculations** – Calculations based on the IEEE Std 1584 methodology to assess the approach distances, Incident Energy generated by an arcing fault, and hazard rating categories. The calculations are the mechanism for assessing the Arc Flash Exposure Consequences

**Arc Rated PPE** – PPE that affords the wearer with protection from an electric arc up to an exposure level defined by the rating of the clothing

**Backup Protection** – Should primary protection fail to operate; backup protection is the next protection relay and circuit breaker combination to detect and clear an electrical fault. For an arcing fault occurring on a switchboard’s main incomer, this is typically the first upstream feeder protection

**Bolted Fault Current** – A fault current flowing where there is close to zero resistance or impedance in the fault path

**Contributing Branch** – A connection to the switchboard through which a portion of the total arcing fault current originates

**Corporation** – The Water Corporation (of Western Australia)

**Design Manager** – The Corporation officer appointed to manage the project design process **Designer** – Refer to DS20

**Flash-protection Boundary** – An approach limit at a distance from live parts that are uninsulated or exposed within which a person could receive a second degree burn during an electrical arc event. Also referred to as closest approach distance

**Hazard Risk Category (HRC)** – A rating factor used by NFPA70E to nominate the incident energy that may exist within the specified working distance due to an arcing fault

**IEEE Std 1584** – U.S. guide for performing arc flash calculations. This standard is widely used in the absence of an equivalent IEC or Australian standard

**Incident Energy** – The amount of energy impressed on a surface, a certain distance from the source, generated during an electrical arc event. In this report Incident Energy levels are calculated based on the concepts / formulas presented in IEEE Std 1584

**Network Operator** – The supply authority controlling the operation of the electrical supply network

**NFPA 70E** – U.S. regulatory Standard for Electrical Safety in the Workplace. NFPA 70E references IEEE Std 1584 as one of a number of methods that can be used to assess arc flash hazards

**PPE** – Personal protective equipment

**PPE Category** – The rating of the PPE aligned to the incident energy intervals defined in NFPA70E

**Primary Protection** – The fastest protection relay and circuit breaker combination to detect and clear an electrical fault. For an arcing fault occurring on a switchboard's main busbar this is typically the incomer protection

**Senior Principal Engineer** – Senior Principal Engineer, Electrical Engineering, Electrical Standards Section, Engineering Branch, Water Corporation

**Switchboard** – Includes HV and LV switchgear, motor control centres, variable speed drive cubicles, power factor correction cubicles, harmonic filter cubicles, motor starter cubicles or any other electrical cubicle containing HV and/or LV primary power circuits

**Working Distance** – The dimension between the potential arc point and the head and body of the worker positioned to perform the assigned task

## 4 MANDATORY REQUIREMENTS

In general, the requirements of this standard are mandatory. If there are special circumstances which would justify deviation from the requirements of this standard, the matter shall be referred to the Senior Principal Engineer for consideration. No deviation from the requirements of this manual shall be made without the written approval of the Senior Principal Engineer.

## 5 BACKGROUND

### 5.1 Definition of an Arc Flash

An arc flash is an unexpected release of electrical energy with the potential for serious or possibly fatal injury to workers exposed to the arc.

An arc flash event occurs when there is an insulation breakdown between two conductive surfaces of different potential. This would typically be between phases or phase/s and earth of an HV/LV electrical system. The breakdown results in a 'short circuit' through the air separating phases or phase/s and earth.

Some possible causes of an arc flash are:

- Momentary shorting due to, for example, a dropped tool or bolt, or accidental contact with live parts

- Ionisation of air due to over-heating (hot-spots) or transient over-voltage (e.g. lightning)
- Solid insulation deterioration due to partial discharge or ageing
- Pollution by water, dust, or foreign matter
- Corrosion
- Conductive dust particles
- Misalignment of moving contacts
- Entry of foreign bodies (e.g. insects, rodents, snakes)

Once initiated, the arc flash can rapidly develop into a plasma cloud. High temperatures within the initial arc path break the air molecules into a plasma of positive and negative ions, which are electrically conductive. The electrical fault current flows through this conductive path in the air, dissipating a large amount of energy. The energy is released as an instantaneous explosion of light, heat, hot gases and molten metal, with temperatures of up to 20,000°C.

The resulting rapid and destructive expansion of air and vaporised metal often leads to switchboard structural failure and the explosive propulsion of molten metal, dislodged panels/doors, equipment parts and other debris at speeds of up to 300 m/s.

An arc flash is an unexpected, uncontrolled event, and should not be confused with the interruptions of electrical arcs within electrical switchgear as a result of current switching. When current is rapidly interrupted during switching, an arc is drawn between the separating contacts. Switchgear (load break switches, circuit breakers, fuses, contactors) are designed to safely quench this arc.

## 5.2 Consequences of an Arc Flash

The consequences for personnel exposed to an arc flash incident are potentially very serious and can result in death. Typical exposure consequences are:

- Severe burns – arc plasma, radiation and the secondary burns from the ignition of flammable clothing
- Burns – metal spray and material combustion
- Electric shock/electrocution from the projected arc plasma
- Pressure wave – lungs, eyes, ears trauma
- Pressure wave – secondary injuries from projectiles and shrapnel
- Poisoning – toxic gasses

Financial losses and equipment damage may also result from arc flash incidents and typically present as:

- Initial explosive damage
- High temperature melting
- Fire damage
- Carbon deposits reducing insulation quality
- Consequential damage
- Adjacent panel damage
- Auxiliary plant damage

## 5.3 Goals of an Arc Flash Incident Energy Assessment

The goals of an arc flash hazard assessment are to:

- Evaluate the potential severity (consequences) of a switchboard arc flash incident by evaluating the prospective heat energy produced by an arcing fault

- Evaluate the safe working distance from energised electrical switchboards on the basis of the potential arc fault energy
- Propose and develop options for reducing arc flash hazards
- Determine Arc Rated PPE requirements for employees working on or near electrical switchboards
- Provide a reasonably practicable safe work environment

## 5.4 Standards and Available Tools

The majority of work and developments in arc flash have come from the U.S. where there are specific legislative requirements around the assessment of arc flash hazards, and the provision of AR PPE.

The most common methods of arc flash hazard assessment and resulting AR PPE specification used in the U.S. are:

- NFPA 70E (Standard for Electrical Safety in the Workplace, which includes tables providing generalised approximate (but conservative) PPE levels based on a hazard category associated with the type of work activity undertaken)
- IEEE Std 1584 (Guide for Performing Arc Flash Hazard Calculations), which provides techniques for designers to apply in determining the arc flash hazard distance and incident energy to which people could be exposed during their work on or near electrical equipment. The IEEE Std 1584 provides an empirically derived calculation model based on laboratory testing and subsequent statistical modelling and curve fitting, and applies to systems fitting specified test range criteria (refer to Section 6)
- The Lee method (developed by Ralph Lee) is a theoretically derived arc flash calculation model. The method is referenced by IEEE Std 1584 as an approach to follow where the empirical methods presented in IEEE Std 1584 are not suitable (refer to Section 6)

Although a U.S. standard, IEEE Std 1584 has become the most widely used method to evaluate switchboard arc flash hazards in Australia, largely due to the lack of authoritative Australian Standards or guidelines.

AS/NZS 4836 covers safe working on or near low-voltage electrical installations and equipment. The standard includes a cursory consideration of arc flash safety and PPE requirements, but does not provide any guidance or methods of calculating incident energy or assessing arc flash risk.

The electrical industry has identified the need for the development of an Australian-based approach dealing with arc flash hazard incident energy, risk assessments and effective mitigation methods. As a result, a working group has been established to produce an Australian Standard covering arc flash hazards. However, the development of the standard is ongoing, and the industry has not been notified of an official release date yet.

## 6 PERFORMING ARC FLASH ASSESSMENTS

Arc Flash Hazard Assessments shall be carried out during Engineering Design.

The IEEE Std 1584 method of arc flash calculation shall be used for Arc Flash Hazard Assessments of Water Corporation LV switchboards, HV switchboards up to 15kV and other switchgear assemblies as outlined in clause 1.1.

Water Corporation has switchboards operating at voltages above 15kV, including switchgear operating at voltage levels of 22kV and 33kV. For these boards the IEEE Std 1584 empirical equations become increasingly inaccurate and invalid as the voltage increases and therefore the Lee Method shall be used. This method does not take into account the magnifying effects of an ‘*arc in the box*’, but this is somewhat balanced by the fact that the Lee Method of calculation is more conservative.

The specific outcomes and requirements for performing arc flash assessments are described in Clause 6.1 to Clause 6.14.

### 6.1 Outcomes of an IEEE Std 1584/Lee Method Assessment

The outcomes of an IEEE Std 1584/Lee method assessment are as follows:

### 6.1.1 Incident Energy at the Working Distance

The incident energy at the working distance is the amount of energy a surface (or person) exposed to an arc flash will experience at a set distance from an arc. The incident energy reduces exponentially as the distance between the person and the arc source increases.

### 6.1.2 Arc Flash Boundary (Closest Approach Distance)

The arc flash boundary is the distance from live parts within which a person without AR PPE could receive a second degree burn. Outside of the boundary the assessed energy levels are below 1.2 cal/cm<sup>2</sup>, within the boundary the energy levels are 1.2 cal/cm<sup>2</sup> or above.

### 6.1.3 Hazard Rating Category

Once the incident energy has been assessed a Hazard Rating Category can be assigned. The NFPA 70E defines five Hazard Rating Categories (Category 0 – 4), according to specified ranges of incident energy (refer to Table 6).

## 6.2 Assessment Process

There is a trade-off between protection grading and arc flash hazard reduction as discussed later in Section 10.1. Therefore to balance these competing requirements arc flash hazard assessments shall be performed in conjunction with the protective devices coordination studies required by DS20 during engineering design.

## 6.3 Assessment Scenarios

Figure 2 below illustrates the three possible locations on a switchboard where an arc flash could occur:

- Location 1 – Incomer terminals on the line side of the incomer protection
- Location 2 – Terminals, main busbars and droppers located between the main incoming protection and the outgoing feeder protection
- Location 3 – Feeder terminals on the load side of the outgoing feeder protection

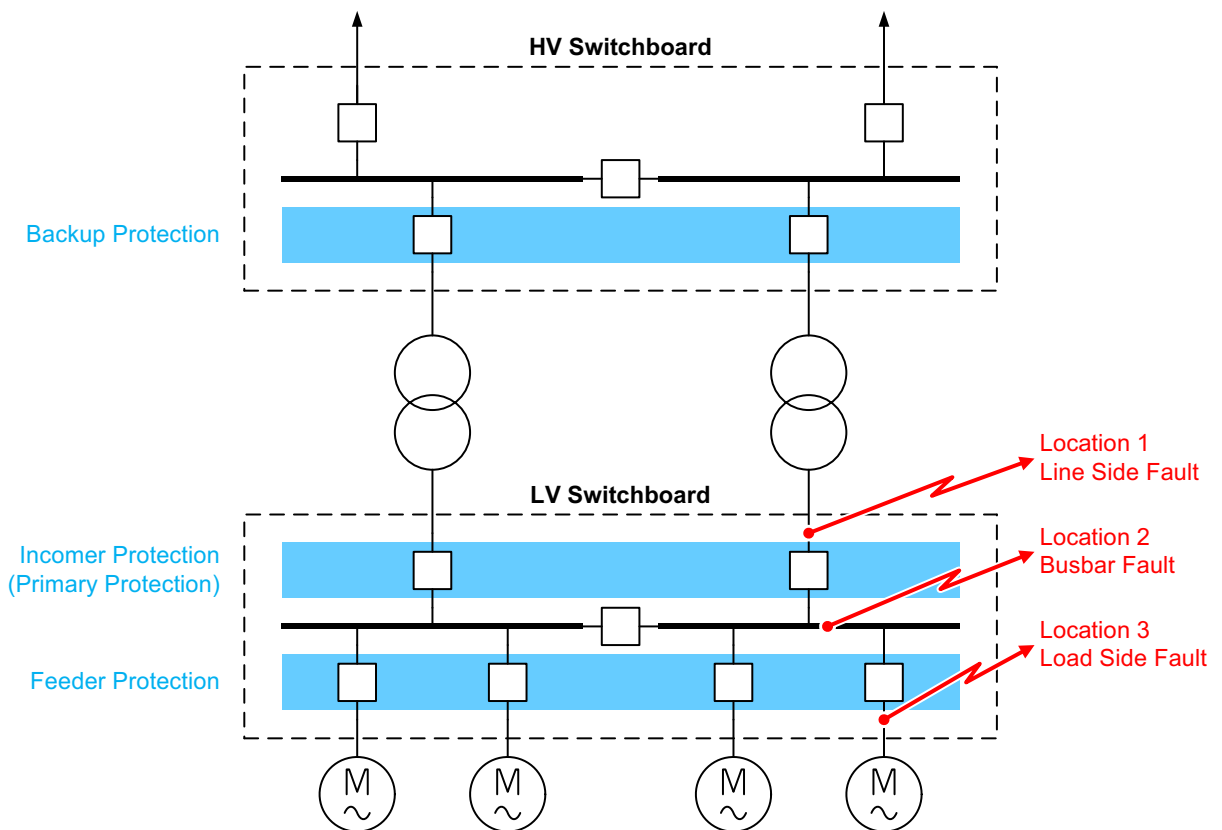

Figure 2 Arc Flash Locations

The arc flash incident energy is different at these three locations because at each of the locations a different protection device (with a different operating time) acts to interrupt the arc.

For the most common scenario where the upstream (remote) feeder overcurrent protection is graded with the switchboard's incoming overcurrent protection which in turn is graded with the switchboard's outgoing feeder overcurrent protection, the severity of the incident energy is as follows:

- The upstream (remote) feeder protection acts for a fault at Location 1. The incident energy release at Location 1 is the most severe relative to Location 2 and 3 because the upstream (remote) feeder protection is slower than both the switchboard's incoming and outgoing feeder protection
- The switchboard's incoming protection acts for a fault at Location 2. The incident energy release at Location 2 is less severe than Location 1 because the incomer protection is faster than the upstream (remote) feeder protection
- The switchboard's outgoing feeder protection acts for a fault at Location 3. The incident energy release at Location 3 is generally less severe than both Location 1 and Location 2 because outgoing feeder protection is faster than both the incoming and the upstream protection

Arc flash calculations shall be undertaken at both Location 1 and Location 2, as required by Section 7.

Calculations are not required at Location 3. This is to avoid the necessity of having to undertake a large number of calculations to cover all of the outgoing circuits on a switchboard. Also, this avoids the increased operational complexity arising from specifying many different PPE categories and incident energy levels for a single switchboard. Furthermore, there is the potential for an arc flash which initially occurs on an outgoing feeder (Location 3) to propagate to Location 1 and/or 2. Thus a conservative and practical approach is to base incident energy levels on Location 1 and 2.

In particular situations the incident energy at Location 1 and 2 will be the same and therefore only one calculation covering both Location 1 and 2 is required, such situations include:

- There is no incoming protection device including where the incomer is a switch or a non-automatic circuit breaker
- The incoming protection and the backup protection have the same characteristic time current curve with the same operating time for an arcing fault at Location 1 or 2
- There is protection malgrading between the incomer and the upstream protection, resulting in the upstream protection operating before the incoming protection for an arcing fault at Location 1 or 2
- Where a more sophisticated (than graded overcurrent) unit protection scheme exists, which would operate for a fault occurring at both Location 1 and 2. In the context of arc flash protection an arc detection system is the most common example of a unit protection scheme

The application of the different assessment scenarios to develop an arc flash warning label and specify the PPE requirements for different operational tasks is covered in detail in Section 7

## 6.4 Arc Flash Assessment Overview – Steps

The following steps must be completed when performing an arc flash study for both HV and LV switchboards:

- Collect the system and installation data
- Prepare a software model of the electrical system
- Determine the bolted fault current
- Determine the bus gaps  
*Note: The bus gap is not required when using the Lee Method to assess switchboards above 15kV*
- Convert bolted fault current to arcing fault current  
*Note: This step is not required when using the Lee Method to assess switchboards above 15kV, the arcing fault current is taken to be equal to the bolted fault current*
- Assess the duration of the arcing fault



- Identify working distances
- Determine the incident energy at the working distance
- Determine the ‘worst case’ incident energy
- Determine the arc flash boundary for the ‘worst case’ incident energy

## 6.5 Collecting the System and Installation Data

For each switchboard under assessment the data that is required for modelling of the electrical system in order to carry out arc flash incident energy level assessments is described in Clause 6.5.1 to 6.5.8.

### 6.5.1 Utility Fault Contribution

The fault current contribution shall be confirmed with the power supply utility at the point of supply and modelled as follows:

- Maximum three phase initial symmetrical fault level (or equivalent impedance)
- Minimum three phase initial symmetrical fault level (or equivalent impedance)
- X/R ratio of the supply network impedance, for both the maximum and minimum fault level cases

*Note: The incident energy calculation models are based on three phase arcing faults. The IEEE Std 1584 reasons that single phase faults and line to line faults can escalate very quickly into three phase faults, and therefore the conservative approach is to base the calculation on three phase arcing faults.*

### 6.5.2 Generators

#### 6.5.2.1 On-site Generators

The following information shall be modelled for generators permanently installed on a site:

- kVA rating
- Rated power factor
- D-Axis sub-transient reactance ( $X_d''$ )
- Stator resistance ( $R_g$ )

#### 6.5.2.2 Portable generators

The Water Corporation has a significant number of switchboards supplied frequently by portable generators of various sizes. Since no practice or guideline was available to identify the arc flash hazard level on these switchboards when supplied by a portable generator, an arc flash energy sensitivity study for switchboards supplied from a portable generator using a rule-based approach (refer Jacobs report number RO145400-EE-RP-001 | 0) has been developed.

The data collected on a number of generators was used to determine arc flash incident energy levels for various sizes of temporary generators. The studies have been carried out to determine the worst-case arc incident energy by considering the maximum fault currents, fault durations and motor contributions. The conditions to reduce the incident energy and thus achieving a lower hazard risk category (HRC) level have also been explored. These conditions should be checked or set by the operators on-site if the HRC level is required to be less than the worst-case level presented in this design standard, Appendix B.

In summary:

- The first stage of estimation of hazard rated category shall be carried out using the information provided in Appendix B using the cell identified as ‘Highest Expected Hazard Category’. This is a conservative estimation of the HRC using only the generator output capacity stated in the table
- The next stage of HRC estimation can be carried out using the additional information (knowledge of protection device and settings) provided in the table
- Should any further accurate assessment of arc flash incident energy levels be required then assessment shall via the full arc flash hazard assessment procedure

### 6.5.3 Transformers

The following information shall be modelled for transformers:

- Primary and secondary voltage ratings
- Primary and secondary winding connections
- kVA rating
- Tap position
- Positive sequence transformer impedance (%z)
- Positive sequence X/R ratio

*Note: As an alternative to %z and X/R ratio, the %X and %R values can be modelled.*

The following assumptions are acceptable where information is not available:

- Nominal tap position (position '0' in PTW)
- Transformer X/R ratio of 10 for transformers rated below 10 MVA (as per AS 3851)
- Primary transformer winding: Delta
- Secondary Winding: Star
- Impedance, transformers  $\leq 2$  MVA: as per DS 21 Section 7.8
- Impedance, transformers  $> 2$  MVA: as per AS 60076.5 Table 1

### 6.5.4 Cables

The following cables shall be modelled:

- Distribution cables between the utility point of supply and a switchboard under assessment
- Cables used to provide alternate supply sources such as bus-ties, back-feeds, etc
- Cables supplying sub-distribution boards if the downstream board supplies induction motors
- Cables supplying the largest induction motor supplied from the board under assessment

The following information shall be modelled for cables:

- Conductor resistance and reactance values
- Number of conductors in parallel
- Conductor length

For LV cables the resistance and reactance values of cables can be obtained from the manufacturer technical catalogues or AS/NZS 3008.1.1.

### 6.5.5 Protection Device Characteristics

The primary, backup and largest outgoing feeder protection overcurrent device time current characteristics shall be modelled. Modelling shall include:

- The time current characteristic settings of the protection device
- The upper and lower operating time tolerance bands of the time current tripping characteristic
- Both the detection time and the circuit breaker opening time shall be included in the model. Where a protection device is a circuit breaker with integral trip unit, the time current characteristic provided by the manufacturer typically represents the combined detection and opening time. Where the protection relay and circuit breaker are separate devices, the circuit breaker opening time shall be specified as a separate modelling parameter

*Note:*

- *There is the facility to model arc flash detection relays or other special instantaneous protection schemes in PTW. However, where a protection scheme has a fixed clearance time independent of the value of arcing current, the protection modelling of the device is not a requirement*
- *Based on the 'worst-case' assumption that arcing faults quickly escalate into three phase balanced faults, earth fault protection cannot be relied upon to clear an arcing fault. Thus, modelling of earth fault protection devices is not a requirement for arc flash assessment*
- *For some facilities the backup protection is provided by the upstream utility protection device, requiring liaison with the power utility*

### 6.5.6 Switching Points

The model shall include all switching points which could affect the fault current levels, within the site distribution boundary. This includes HV and LV switching points such as:

- Ring main switches
- Bus-ties
- Isolation points for contingency supply arrangements (i.e. 'Emergency feeder')

### 6.5.7 Loads

The system model shall include all loads on the site that may contribute to the overall fault levels

This includes:

- Induction motors connected direct on-line
- Induction motors connected by starters which are bypassed after starting, i.e. Star-Delta, autotransformer, soft-starter
- Motors connected by regenerative-type variable speed drives ('four quadrant' drives)

Modelling static loads, or motors supplied from non-regenerating variable speed drives is not required.

Motors shall be included based on the worst-case motor running scenario. For example, where three pumps are installed, with one designated for standby operation, only the two duty pumps need to be included in the model.

The largest induction motor supplied from the switchboard under assessment shall be individually modelled. The remaining induction motors can be lumped together into a single motor with a kW rating constituting the total of the lumped motors. Motors on other switchboards within the same facility as the board under assessment shall be modelled as lumped loads connected to their respective boards.

On multi switchboard sites where an existing model is not available (or where induction motors are missing from the model) and the arc flash assessment does not extend to all of the switchboards on the site, it may be acceptable to neglect motor contributions from induction motors on boards which are not being assessed. However, a sensitivity analysis shall be undertaken to confirm that these induction motor contributions have a negligible effect on fault levels at the board under assessment.

The following information should be modelled for motors:

- Motor kW rating
- Motor efficiency
- Power factor
- Locked rotor current

The following assumptions are acceptable where information is not available:

- Power factor: 0.85
- Motor efficiency: 0.9
- Locked rotor current:  $7 \times FLA$

## 6.5.8 System Busses

The nominal operating voltage shall be included in the model for all busses and terminals.

## 6.6 Preparing a Software Model of the Electrical System

A model of the electrical system shall be developed in SKM Power Tools for Windows (PTW) in sufficient detail to:

- Allow the maximum and minimum initial symmetrical three phase fault levels to be determined at the bus of the switchboard under assessment
- Allow the protection clearance time under maximum and minimum arcing fault conditions to be evaluated

The terminal points for modelling shall include the components of the electrical distribution system from the utility point of supply up to the bus-bars of the switchboards under assessment, as well as any other sources of fault current including generators and induction motors that would contribute fault current in the event of an arcing fault, including induction motors downstream of the board under assessment.

An arc flash evaluation tool is available for PTW. Once the model has been accurately setup the arc flash tool can be used to automatically calculate the incident energy, arc flash boundary and hazard rating categories.

An alternative approach, if the PTW arc flash evaluation tool is not available, is to manually calculate arc flash hazard parameters. Manual calculation involves extracting the bolted fault currents from PTW and trip times from the protection device time current curves. The IEEE Std 1584 empirical equations (for switchboards  $\leq 15\text{kV}$ ) or the Lee Method theoretical equations (for switchboards  $> 15\text{kV}$ ) can then be applied (in a spreadsheet format or otherwise) to calculate arc flash parameters using the bolted fault currents and trip times as inputs.

Where new switchboards are being installed at an existing facility, Water Corporation should be consulted to obtain the existing model of the facility's electrical system, where available. In some cases, the existing model may not be current, and shall be updated by the designer prior to its use for Arc Flash Hazard Assessments.

## 6.7 Determine the Bolted Fault Current

To calculate the arcing fault current at a switchboard the bolted fault current is first calculated and then converted into an arcing fault current (refer to Section 6.9).

### 6.7.1 Determining the System Modes of Operation

The system operating mode impacts on the prospective short circuit current at a switchboard.

Where a switchboard is supplied via a single radial utility feed there is only a single mode of operation that needs to be considered. However, it is not uncommon to have switchboards supplied by distribution systems with more than one possible mode of operation, for example:

- Sites with two utility points of supply (typically associated with large sites such as waste water treatment plants)
- Ring main distribution networks with an open point at one of multiple possible ring main switching locations
- Embedded generators that can operate islanded or in parallel with the utility supply
- Sites which have an emergency backup generator for supply in the event of a mains failure
- Dual feeds to switchboards providing either single or parallel supplies
- Bus-sectionalisers which can be opened or closed

*Note: Generator modes of operation only need to be considered where they are permanently installed on a site.*

### 6.7.2 Calculating Maximum and Minimum Three Phase Bolted Fault Levels

In order to identify the 'worst case' incident energy (refer to Section 6.13), calculations for both the minimum and maximum fault current conditions must be undertaken.

This is because the relationship between current and time associated with some protective devices (extremely inverse or definite time elements in particular) can cause a disproportionately large increase in protection operating time with only a small decrease in current. This effect can result in higher levels of incident energy for lower fault currents.

Some situations where this can occur are shown in Figure 3 and Figure 4.

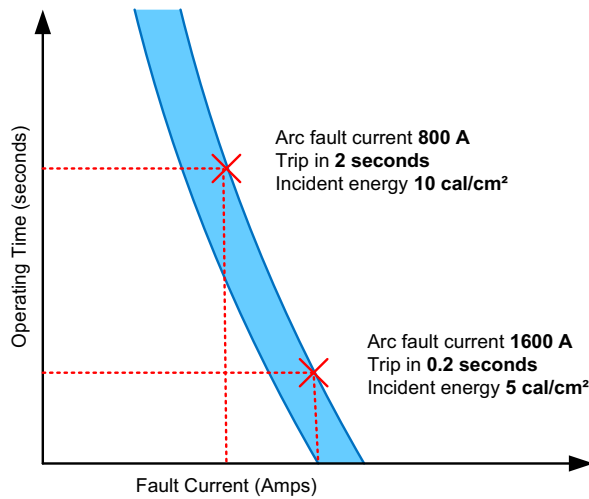

Figure 3 Typical LV fuse Curve.

The fuse curve is so steep that an 800 A fault current takes ten times longer to clear, as compared to a 1,600 A fault current.

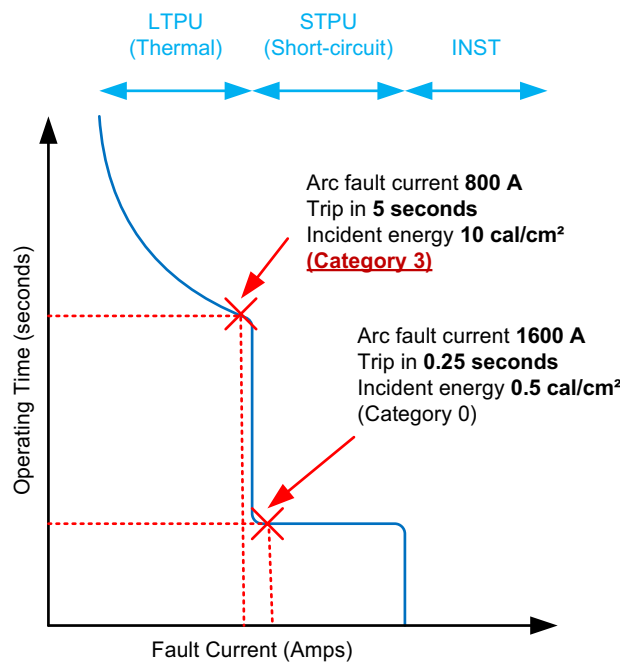

Figure 4 Typical LV breaker curve

Small reduction in fault current causes fault to be cleared on LTPU in 5 s rather than STPU in 250 ms.

The minimum and maximum three phase bolted fault levels shall be identified for each switchboard by considering the different system modes of operation (refer to Section 6.7.1), and in addition, applying pre-fault voltage factors and excluding or including induction motor contributions.

For the majority of cases where there is only a single possible mode of operation.

Table 1 describes the voltage factors and induction motor contributions that shall be used to determine the maximum and minimum three phase bolted fault levels.

Table 1: – Conditions for Calculating Maximum and Minimum Fault Levels with a Single Mode of Operation

| Fault Level Scenario | Operating Conditions and Voltage Factors |                 |                |                              |
|----------------------|--|-----------------|----------------|------------------------------|
|                      | Utility Fault Contribution               | Voltage Factors |                | Induction Motor Contribution |
|                      |  | Voltage ≤ 650V  | Voltage > 650V |                              |
| Minimum fault level  | Minimum                                  | 0.94            | 0.9            | Motor contributions included |
| Maximum fault level  | Maximum                                  | 1.06            | 1.10           | Motor contributions included |

Where a facility has multiple modes of operation Table 2 describes the operating conditions, voltage factors shall be used to determine the maximum and minimum three phase bolted fault levels at the switchboard.

Table 2: – Conditions for Calculating Maximum and Minimum Fault Levels with Multiple Modes of Operation

| Fault Level Scenario | Operating Conditions and Voltage Factors       |                            |                 |                |                              |
|----------------------|--|----------------------------|-----------------|----------------|------------------------------|
|                      | Operating Mode                                 | Utility Fault Contribution | Voltage Factors |                | Induction Motor Contribution |
|                      |  |                            | Voltage ≤ 650V  | Voltage > 650V |                              |
| Minimum fault level  | Minimum prospective fault level operating mode | Minimum                    | 0.94            | 0.9            | Motor contributions included |
| Maximum fault level  | Maximum prospective fault level operating mode | Maximum                    | 1.06            | 1.10           | Motor contributions included |

Note: The PTW arc flash short circuit study module allows voltage factors to be applied

## 6.8 Determining Bus Gaps

The bus gap is defined as the dimension between adjacent phases at a possible arc point. If known the actual bus gap should be used or alternatively the typical bus gaps, as defined in IEEE Std 1584, can be used as defined in Table 3. The Lee Method does not require the bus gap as a calculation input.

Table 3 Bus Gaps

| Class of Equipment   | Bus Gap   |
|--|---|
| Switchgear > 15kV  | Lee method assessment – does not require bus gap. |
| 11kV Switchgear (up to 15 kV)                                  | 152 mm  |
| 3.3kV and 6.6kV Switchgear                                     | 104 mm  |
| LV switchgear and motor control centres                        | 32 mm   |
| LV starter cubicles, Form 1 switchboards, distribution boards. | 25 mm   |

## 6.9 Converting Bolted Fault Currents to Arcing Fault Currents

For switchboards operating at voltages above 15kV, based on the Lee Method, the arc fault current is taken to be equal to the bolted fault current. The Lee Method does not require the arcing current to be calculated on the basis that the arcing current is approximately the same as (marginally lower than) the bolted current at higher voltages.

For switchboards operating at voltages of 15kV or lower the IEEE Std 1584 provides equations to convert the bolted fault current into an equivalent arcing fault current. The arcing current is always less than the bolted fault current due to the additional arc resistance in the fault path that does not exist for a bolted fault.

The following input parameters are used to calculate the arcing current for voltages less than 1kV using the IEEE Std 1584 equations:

- The nominal switchboard voltage
- The gap between conductors (refer to Clause 6.8)
- The bolted fault current (refer to Clause 6.7)
- A factor (K) to adjust for differences arising from arcing within unenclosed versus enclosed spaces. For switchboards the enclosed space factor of  $K = -0.097$  shall be used

For voltages greater than or equal to 1kV only the bolted fault current is required as an input to calculate the arcing current.

*Note:*

- *The PTW Arc Flash Evaluation Tool automatically converts the bolted fault current to arcing fault current*
- *The empirical equations used to convert bolted fault current to arcing fault current are available within the IEEE 1584 standard*

### 6.9.1 Identifying arc fault current contributing branches

Arcing fault current may originate from a single contributing branch, as would occur for a switchboard with no induction motors supplied from a single incoming feeder. Or arcing fault current may originate from multiple contributing branches, for example a switchboard with parallel incomers and/or induction motors.

The arc fault current contributions from each branch are determined by assessing the total arcing fault current at the arc location, and then dividing this total arcing current among the contributing branches in the same proportion as the bolted fault current branch contributions assessed in the PTW model.

When the arc initiates all of the branches contribute arcing current until the first branch clears. Once the first branch clears the arc fault current 'steps down' by an amount corresponding to the cleared branch. This continues until all the branches have cleared and the arcing fault current is reduced to zero.

The staggered clearance of each branch creates separate assessment regions, shown as 1, 2 and 3 in Figure 5 below. To calculate the incident energy a separate IEEE Std 1584 assessment is undertaken for each region and, based on the principle of superposition, the algebraic sum of the incident energy for each region yields the total incident energy for the switchboard.

*Note: The PTW Arc Flash Evaluation Tool automatically considers the energy from parallel contributions to determine the total incident energy. If the manual calculation approach is followed then separate calculations for each assessment region (see Figure 2) shall be undertaken, and added together to arrive at the total incident energy.*

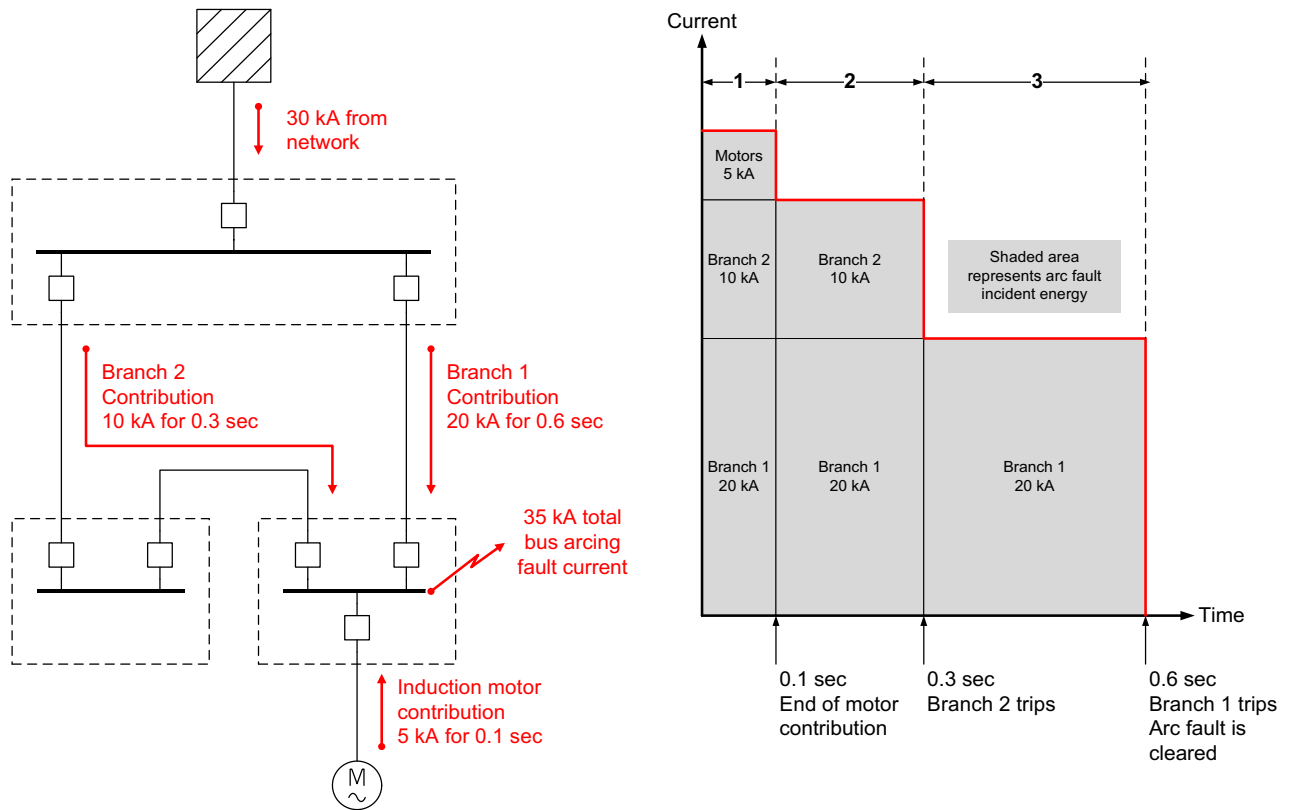

Figure 5 Arc Flash Contributing Branches

## 6.9.2 Identifying Induction Motor Contributions

Induction motors behave as generators for a short duration (up to 5 cycles) during a fault. The combined contribution from the induction motors shall be treated as a separate contributing branch with the fault current contribution remaining constant for 5 cycles (100 ms), and then decaying rapidly (approximated as an instantaneous step down to zero current after 5 cycles).

*Note: If using the PTW Arc Flash evaluation tool the induction motor contribution can be setup to contribute for a specified number of cycles.*

## 6.10 Assessing the Duration of the Arcing Fault

The duration of the arcing fault is determined by assessing the clearance time of protection devices under arcing fault conditions.

The ‘fastest acting’ protection device which would clear the arcing fault shall be identified for each calculation location. As described in Clause 6.3, this will depend on the location of the fault. For a fault occurring at Location 2 (busbars) the ‘fastest acting’ protection device is usually the incomer device, and for a fault occurring at Location 1 (line side) is usually the upstream feeder protection.

However, in some cases the upstream feeder protection can be the ‘fastest acting’ protection. For example, if there is malgrading between the upstream and incomer protection or if incomer protection does not exist.

The ‘fastest acting’ protection can also be a unit protection scheme such as an arc flash detection system.

For an overcurrent protection device the trip time is determined using the time-current trip characteristic of the protection device (trip time is a function of the arc fault current and the device’s time-current trip characteristic). Where the time-current trip characteristic includes an upper and lower tripping tolerance, the worst-case trip time shall be used.



For a unit protection schemes, such as an arc flash detection system, the trip time shall be determined using the manufacturer datasheets.

As discussed in Clause 6.5.5 the arcing duration shall include both the relay detection time and the circuit breaker opening time.

The arc flash calculation models produce results that are demonstrably unreliable for longer arcing durations. For this reason and also because a person is unlikely to remain in the location of the arc flash for longer than 2 seconds, the calculations shall use a maximum arc duration of 2 seconds.

*Note: The PTW Arc Flash Evaluation Tool automatically determines the arcing duration once the protection devices have been modelled.*

## 6.11 Determining Working Distances

The working distance is defined as the distance between the closest possible arc point and the head and body of a person conducting work. The IEEE Std 1584 defines generalised working distances for different classes of equipment. The working distances, defined in Table 4 – obtained from IEEE Std 1584, shall be used.

Table 4 Working Distances

| Class of Equipment | Working Distance |
|--------------------|------------------|
| HV Switchboards    | 910 mm           |
| LV Switchboards    | 455 mm           |

## 6.12 Determining the Incident Energy at the Working Distance.

For voltages above 15kV the Ralph Lee Calculation Method shall be used to calculate the incident energy. The Lee Method equation requires the following input parameters:

- The nominal switchboard voltage
- The bolted fault current (refer to Clause 6.7)
- Arc duration (protection device clearance time – refer to Clause 6.10)
- The working distance (refer to Clause 6.11)

*Note: The theoretical Lee Equations are available within the IEEE Std 1584.*

The IEEE Std 1584 provides equations for installations between 0.208kV and 15kV to calculate the incident energy at a specified working distance.

The following parameters are used to calculate the incident energy for voltages between 0.208 and 15kV using the IEEE Std 1584 equations:

- Arcing current (refer to Clause 6.9)
- The working distance (refer to Clause 6.11)
- The gap between conductors (refer to Clause 6.8)
- Arc duration (protection device clearance time – refer to Clause 6.10)
- A factor (K1) to adjust for differences arising from arcing within unenclosed versus enclosed spaces. For switchboards the enclosed space factor of  $K1 = 0.555$  shall be used.
- A factor (K2) to adjust for differences arising from the method of system earthing. For solid earth systems (all LV switchboards and majority of HV boards) the earthing factor of  $K2 = 0.113$  shall be used. Where HV boards earthed via a resistor or other impedance device the earthing factor of  $K2 = 0$  shall be used
- A factor ( $C_f$ ) to adjust for difference between LV and HV systems. For systems with nominal voltage above 1kV a factor of  $C_f = 1$  shall be used, for voltages at or below 1kV a factor of  $C_f = 1.5$  shall be used
- A distance exponent factor (x) as defined in
- Table 5

Table 5: Distance Exponent Factor

| Class of Equipment                                    | Distance Exponent Factor (x) |
|---|------------------------------|
| 11kV Switchgear (up to 15 kV)                         | 0.973                        |
| 3.3kV and 6.6kV Switchgear                            | 0.973                        |
| LV switchgear and motor control centres               | 1.473                        |
| LV starter cubicles, Form 1 & Form 2 switchboards and | 1.641                        |

Note:

- The factors *K1* and *K2* used to calculate the incident energy are unrelated to the *K* factor used for calculating the arcing current in Clause 6.9
- The PTW Arc Flash Evaluation Tool automatically determines the incident energy at the working distance
- The empirical equations used to calculate incident energy are available within the IEEE 1584 standard

### 6.13 Determining ‘Worst Case’ Incident Energy

As described in Clause 6.7.2 a lower arcing fault current can lead to higher incident energy levels. Thus, to determine the ‘worst case’ incident energy at each assessment location four calculations shall be undertaken considering different possible arcing fault currents levels.

The process is shown in Figure 6. The incident energy shall be calculated at 100% and 85% of the assessed arcing fault current, for both the maximum and minimum bolted fault current. The ‘worst case’ incident energy result is the highest incident energy result from the four calculations.

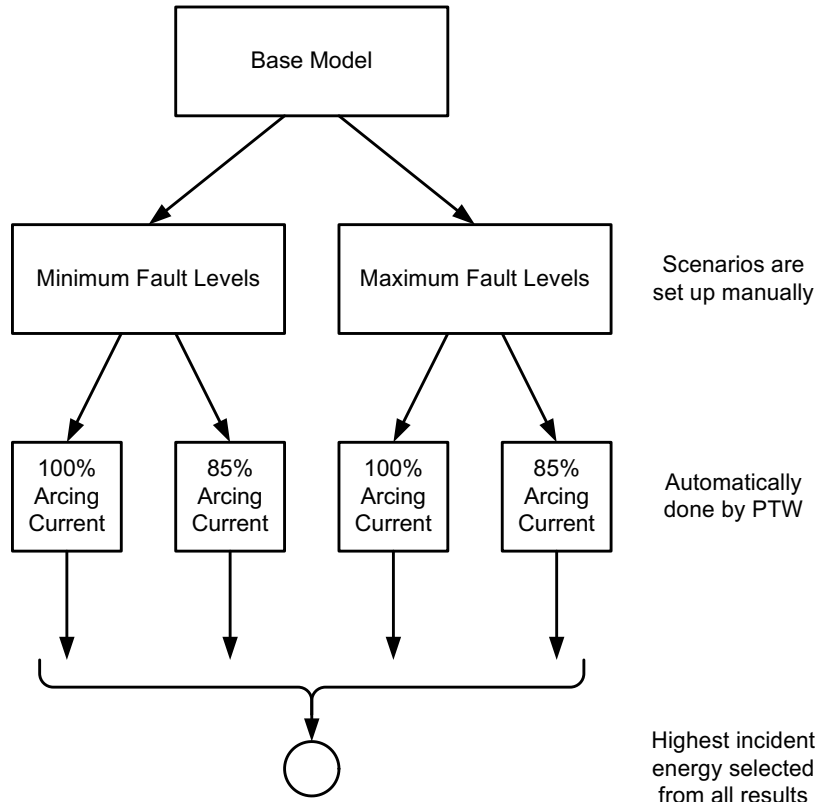

Figure 6 Process to Determine the ‘Worst Case’ Incident Energy

Note:

- The 100% and 85% of arcing fault current calculation cases are required to account for the observed variations between the calculated (predicted) arcing fault current and the measured (actual) arcing fault current
- The minimum and maximum bolted fault scenarios are not handled automatically by the PTW Arc Flash Evaluation Tool, and must be setup as separate study cases prior to using the evaluation tool to calculate the incident energy for both the minimum and maximum cases
- Within the minimum and maximum bolted fault study cases The PTW Arc Flash Evaluation Tool automatically compares the 100% and 85% arc fault current scenarios and selects the one with the highest incident energy

## 6.14 Determining the Arc Flash Boundary

The arc flash boundary is defined as the distance from the closest arc flash point at which a person (without Arc Flash PPE) is likely to receive a second degree burn. The threshold for the onset of a second degree burn is defined to be 1.2 cal/cm<sup>2</sup>.

For voltages above 15kV the Ralph Lee Calculation Method shall be used to calculate the arc flash boundary. The Lee Method equation requires the following input parameters:

- The nominal switchboard voltage
- The bolted fault current (refer to Clause 6.7)
- Arc duration (protection device clearance time – refer to Clause 6.10)

Note: The theoretical Lee Equations are available within the IEEE Std 1584

The IEEE Std 1584 provides equations for installations between 0.208kV and 15kV to calculate the arc flash boundary.

The following parameters are used to calculate the arc flash boundary for voltages between 0.208 and 15kV using the IEEE Std 1584 equations:

- The nominal switchboard voltage
- The gap between conductors (refer to Clause 6.8)
- Arc duration (protection device clearance time – refer to Clause 6.10)
- Arcing current (refer to Clause 6.9)
- A factor (K1) to adjust for differences arising from arcing within unenclosed versus enclosed spaces. For switchboards the enclosed space factor of K1 = 0.555 shall be used
- A factor (K2) to adjust for differences arising from the method of system earthing. For solid earth systems (all LV switchboards and majority of HV boards) the earthing factor of K2 = 0.113 shall be used. Where HV boards earthed via a resistor or other impedance device the earthing factor of K2 = 0 shall be used
- A factor (C<sub>f</sub>) to adjust for difference between LV and HV systems. For systems with nominal voltage above 1kV a factor of C<sub>f</sub> = 1 shall be used, for voltages at or below 1kV a factor of C<sub>f</sub> = 1.5 shall be used
- A distance exponent factor (x) as defined in
- Table 5

Note:

- The factors K1 and K2 used to calculate the incident energy are unrelated to the K factor used for calculating the arcing current in Clause 6.9
- The PTW Arc Flash Evaluation Tool automatically determines the arc flash boundary
- The empirical equations used to calculate the arc flash boundary are available within the IEEE Std 1584

# 7 DETERMINING THE REQUIRED PPE LEVEL

Arc rated PPE is an effective method of protection personnel from burn injuries due to arc flash incidents. However, PPE shall be used as a ‘last line of defence’ against potential exposure and does not replace the requirement to implement mitigation measures to reduce exposure levels, as described in Section 10.

## 7.1 Arc Rated PPE Selection

NFPA70E defines Arc Rated PPE categories which can be used to protect personnel against direct exposure to an arc corresponding to intervals of incident energy as defined in

Table 6.

Table 6 - Assessed Arc Rated PPE Category

| Incident Energy From    | Incident Energy To      | Arc Rated PPE Category |
|-------------------------|-------------------------|------------------------|
| 25 cal/cm <sup>2</sup>  | 40 cal/cm <sup>2</sup>  | Cat 4                  |
| 8 cal/cm <sup>2</sup>   | 25 cal/cm <sup>2</sup>  | Cat 3                  |
| 4 cal/cm <sup>2</sup>   | 8 cal/cm <sup>2</sup>   | Cat 2                  |
| 1.2 cal/cm <sup>2</sup> | 4 cal/cm <sup>2</sup>   | Cat 1                  |
| 0 cal/cm <sup>2</sup>   | 1.2 cal/cm <sup>2</sup> | Cat 0                  |

*Note: The PPE categories assume direct exposure to an arcing fault i.e. switchboard doors/panels open at the time the fault occurs or doors/panels forced open by the internal pressure developed by an arc*

Table 7 defines the selection of PPE categories for use by personnel working on or near to energised switchboards. The PPE definitions are based on the following criteria:

- The incident energy intervals defined in Table 6 for the ‘worst case’ incident energy (Section 6.13)
- Operational activities
- A switchboard’s internal arc rating
- Switchboard doors/panels open or closed
- Possible fault location/s during different activities (location 1 or 2 – Section 7.2)

The PPE requirements are shown either specified as ‘Cat 0’ or required to be determined from calculation of ‘worst case’ incident energy at the locations indicated (Location 1 or Location 2).

Table 7 Arc Rated PPE Selection

| Operational Activity | Minimum PPE Requirements                                     |            |  |            |  |            |
|----------------------|--|------------|--|------------|--|------------|
|                      | Switchboard <b><i>is</i></b> internally arc rated (MCC Type) |            | Switchboard <b><i>is not</i></b> internally arc rated (MCC Type) |            | Outdoor Switchboard (≤440 A, not internally arc rated) |            |
|                      | Doors Closed   | Doors Open | Doors Closed   | Doors Open | Doors Closed   | Doors Open |
|                      |  |            |  |            |  |            |

|  |       |                                       |                                       |                                       |     |                         |
|--|-------|---------------------------------------|---------------------------------------|---------------------------------------|-----|-------------------------|
| Incomer Racking                          | Cat 0 | Location 1 or Location 2 <sup>A</sup> | Location 1 or Location 2 <sup>A</sup> | Location 1 or Location 2 <sup>A</sup> | N/A | Location 2 <sup>A</sup> |
| Incomer Switching                        | Cat 0 | Location 1 or Location 2 <sup>B</sup> | Location 1 or Location 2 <sup>B</sup> | Location 1 or Location 2 <sup>B</sup> | N/A | Location 2 <sup>A</sup> |
| Switching and Racking (Non-incomer)      | Cat 0 | Location 1 or Location 2 <sup>C</sup> | Location 1 or Location 2 <sup>C</sup> | Location 1 or Location 2 <sup>C</sup> | N/A | N/A                     |
| Live Electrical Testing (Power Circuits) | N/A   | Location 2                            | N/A                                   | Location 2                            | N/A | Location 2              |
| Operating Controls                       | Cat 0 | CAT 0                                 | Cat 0                                 | CAT 0                                 | N/A | CAT 0                   |
| Visual Inspection (Live Parts)           | Cat 0 | Location 2                            | Cat 0                                 | Location 2                            | N/A | Location 2              |

**Table Explanation:**

The ‘N/A’ classification assumes that it is not possible, or at least impractical, to undertake live electrical testing with the doors closed, and therefore minimum PPE does not have to be selected.

As described in Clause 6.3 there are a situations where the incident energy at Location 1 and 2 will be the same and therefore only one calculation covering both Location 1 and 2 is required. Where the incident energy is different PPE requirements shall be based on either Location 1 or 2 as per the conditions described below.

**A: Incomer Racking:**

- If the line side busbars and terminals are fully insulated or phase barriered, and the racking device is a moulded case circuit breaker supported and guided by a frame assembly – select PPE Category based on Location 2 (busbar) incident energy assessment
- If the line side busbars and terminals are not fully insulated or phase barriered, or the racking device is not a moulded case circuit breaker supported and guided by a frame assembly – select PPE category based on Location 1 (lineside) incident energy assessment
- If the line side busbars and terminals are fully insulated or phase barriered, and the racking device is an air circuit breaker (manufactured after year 2006) supported and guided by a rigid frame assembly, fitted with fail safe mechanical trip interlocks (cannot be withdrawn or inserted into the busbar when the circuit breaker is closed) and fitted with bus bar shutters – select PPE Category based on Location 2 (busbar) incident energy assessment

**B: Incomer Switching**

- If the line side busbars and terminals are fully insulated or phase barriered – select PPE Category based on Location 2 (busbar) incident energy assessment
- If the line side busbars and terminals are not fully insulated or phase barriered – select PPE Category based on Location 1 (lineside) incident energy assessment

**C: Non Incomer Switching and Racking**

- If the device is located within the same compartment as the incomer (not segregated) – select PPE Category based on the same incident energy assessment location shall be used as for the Incomer (A and B above)

- If the device is located within a separate compartment to the incomer (segregated) – select PPE Category based on Location 2 (busbar) incident energy assessment

*Note:*

*The conditions described above only apply to the selection of PPE categories, the incident energy levels and arc flash boundaries shown on the label and shall be as follows:*

- *Incomer Energy – Location 1 (lineside)*
- *Busbar Energy – Location 2 (busbar)*

## 7.2 Internal Arc Rating

The Australian and IEC standards specify internal arc rating tests for LV switchboards (IEC 61641 and AS34391.1 Appendix ZD) and HV switchboards (AS/IEC 62271.200). These tests provide a level of assurance that under specified conditions a switchboard will either contain the energy released by an arcing fault or direct it away from a person located in the vicinity of the switchboard.

For switchboards which are internally arc rated Category 0 arc rated PPE shall be specified for use while the switchboard doors and panels are closed.

When the switchboard doors and panels are open the board shall be treated as non-tested for internal arcing performance for the purposes of PPE specification.

## 7.3 Doors Open or Closed

‘Doors Open’ refers to situations where there is no door or panel between a person and a switchboard’s live conductors or terminals. An example of a ‘Doors Open’ situation is an open cubicle door on a motor control centre or an open escutcheon on a distribution board.

‘Doors Closed’ refer to situations where there is a door or panel between a person and a switchboard’s live conductors or terminals.

*Note: Covers designed to prevent inadvertent contact with live terminals such as polycarbonate covers do not constitute a closed door scenario as they do not provide an arc flash exposure barrier*

## 7.4 Operational activities

The type of operating activity being undertaken affects the risks of an arc flash occurring and of a worker being exposed to the energy release. PPE shall be specified for the following activities:

- Live Electrical Testing (power circuits) requires the switchboard’s door or panel to be open and includes testing of energised circuits or live switchboard components
- Operating controls located on the switchboard such as motor start / stop, but does not apply to operating controls where the control panel is separate to the switchboard
- Visual Inspection includes any activity where a person is in close proximity to a switchboard, and there is no physical interaction with the switchboard
- Incomer switching
- Non-incomer switching
- Incomer racking
- Non-incomer racking

*Note: Switching includes:*

- Changing the state of an isolator, switch, fuse-switch or circuit breaker

- Manual spring charging
- Operating integral earthing mechanisms
- Inserting and removing fuses

*Racking includes:*

- The action of a device being withdrawn from or inserted onto a switchboard's bus, and applies to isolators, switches, fuse switches and circuit breakers which connect to the switchboard bus via non-fixed (sliding) contact points

## 8 PRODUCING ARC FLASH WARNING LABELS

An adhesive standard arc flash warning label located on the front of the switchboard shall be produced for each switchboard to inform operators of potential arc flash consequences and the required levels of arc rated PPE required for different activities, see Fig 7a. Only one label is required for each switchboard.

The label for outdoor switchboards shall be attached to the external door using UV resistant materials. All labels are to be *Digital onto Cast vinyl with UV over laminate, die-cut* for easy removal. The preferred label supplier is *Jason Sign Makers*, however labels may be sought from others provided the same label material is adhered to.

All the information required for the arc flash warning label shall be captured in tabular format and shown on the Engineering Design Protection Grading drawings (Design Summary or Primary Design drawings).

The following information shall be included on the arc flash warning label:

- Switchboard name
- Date the arc flash assessment was undertaken
- Hazard danger warning symbol in accordance with AS 1319
- Electrical shock risk symbol in accordance with AS1319 (sign no. 448)
- Arc flash boundary while switching (m). The text 'clear space' shall be added after the arc flash boundary distance stated denoting that the arc flash is not obstructed over the boundary distance
- The incident energy level at the working distance (cal/cm<sup>2</sup>)
- A table of minimum arc rated PPE requirements against operational activities with doors open and doors closed (refer to Section 7)
- The nominal voltage
- Where the incident energy levels exceed 40 cal/cm<sup>2</sup> (Category 4), the minimum PPE shall be identified as 'CAT 4\*', with the following qualifying note: '\*Energy Levels Exceed CAT 4 – Follow Risk Assessment'
- Where the incomer is fully insulated or phase barriered, the words 'Incomer Insulated – Risk Assessed' shall be added to denote where the PPE category has been selected based on the reduced Location 2 (busbar) incident energy

Where Generator supplies have been assessed, the switchboard shall have a single 'Hybrid' Dual Supply Arc Flash Warning Label, see Figure 7b

The dimensions of the labels shall be 237 mm W × 182 mm H.

The labels shall be attached prominently in a central, eye-level position on the switchboard.

The templates shown below shall be used for HV and LV switchboards.

**DATE: NOV 2016**

**HAMILTON HILL RESERVOIR –  
 MAIN SB**

\*Energy Level Exceeds CAT 4 – Follow Risk Assessment

| ACTIVITY                                 | Minimum PPE Category |             |
|--|----------------------|-------------|
|  | Door Open            | Door Closed |
| <b>INCOMER</b>                           |                      |             |
| Racking                                  | *CAT 4+              | NA          |
| Switching                                | CAT 1                | CAT 1       |
| <b>NON-INCOMER CIRCUITS</b>              |                      |             |
| Switching or Racking                     | CAT 1                | CAT 1       |
| Live Electrical Testing (Power Circuits) | CAT 1                | N/A         |
| Operating Controls                       | CAT 0                | CAT 0       |
| Visual Inspection (Live Parts)           | CAT 1                | CAT 0       |

**ARC FLASH HAZARD**  
 415VAC Shock Hazard

Figure 7a: Standard Arc Flash Warning Label Format



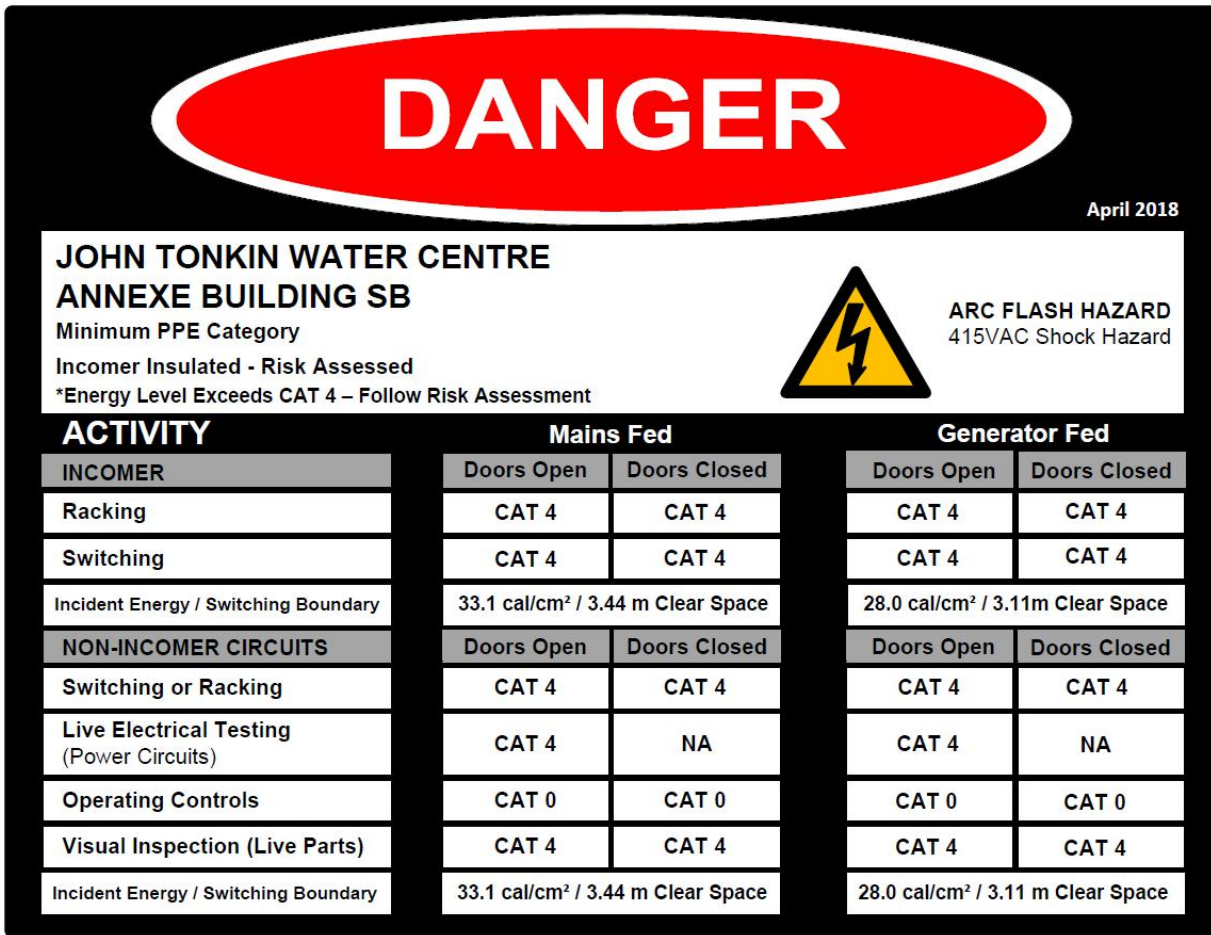

Figure 7b: ‘Hybrid’ Dual Supply Arc Flash Warning Label Format

Where a switchboard is comprised of multiple tiers and has an incoming protection or isolation device a separate adhesive arc flash referral warning label shall be attached to a switchboard’s incoming panel next to the incomer device, see Figure 8.

The following information shall be included on the arc flash referral warning label:

‘Incomer Arc Flash Hazard’ and ‘Refer to the Main Label for Incomer Switching or Racking’.

Electrical shock risk symbol in accordance with AS1319, sign No. 448.

The dimensions of the label shall be 100 mm W x 100 mm H.

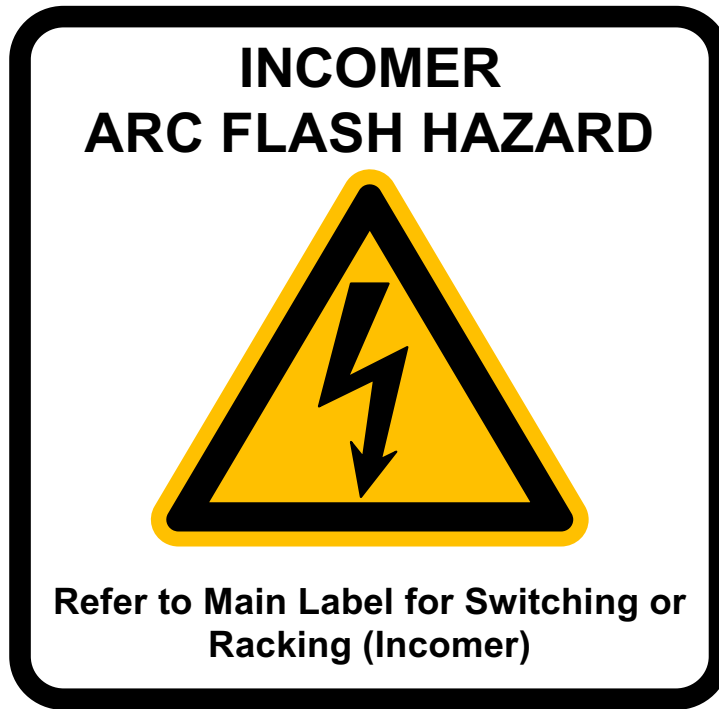

Figure 8: Arc Flash Incomer Referral Warning Label

Where the outcome of the Section 9 short-hand method results in CAT 0 PPE categorisation of the switchboard, the following label should be used in lieu of the full label shown in Figures 7a or 7b above.



The dimensions of the label shall be 170 mm W x 120 mm H.

Where the outcome of the Section 9 short-hand method results in CAT 1 PPE categorisation of the switchboard, the modified standard label shown in Figure 7a shall be used (see Appendix A13.2.1 for example).

## 9 WHERE INCIDENT ENERGY CALCULATIONS ARE NOT REQUIRED

A conservative, short-hand method may be used to assess the PPE requirements for LV switchboards where Conditions 1 and 3 or Conditions 2 and 3 are met as detailed below:

1. The supply is from a supply authority sole-use transformer rated  $\leq 315$  kVA or any supply authority owned street mains (District) transformer which sub-feeds the Water Corporation switchboard.
2. The switchboard is a distribution board and is protected by a dedicated circuit breaker or fuse rated 100 A or less.
3. The line-side terminals and conductors of the incomer are fully insulated, or there are full inter-phase barriers.

This short-hand method eliminates the need to perform arc flash assessment for line-side arc faults, at 'Location 1' (refer to Clause 6.3).

Note that the DS 26 series of standards require line-side insulation for all new Water Corporation switchboards.

For existing equipment, which is being modified, the scope of works shall include the addition of full insulation to the line-side terminals and conductors, where this is practical. Once the line-side insulation is installed, the short-hand method can be applied.

Note: Stage 1 Table 8a, Stage 2 Table 9a and Stage 3 process apply to switchboards fed from a sole-use transformer or a supply authority owned street mains (District) transformer at the point of supply. Where a switchboard is located remote from the main switchboard then Stage 1 Table 8b or Stage 2 Table 9b may be applied or, failing that, calculations will be required to determine the PPE category.

The procedure adopted for determining the arc hazard category using the Stage 3 process is presented in Appendix A13.5 'Example for Stage 3 Assessment'.

To apply the short-hand method:

- If the switchboard is supplied from a transformer rated  $\leq 315$  kVA or a supply authority owned street mains (District) transformer which sub-feeds the Water Corporation switchboard (described in Condition 1 above), first check whether the switchboard can be assessed against the criteria in Table 8a below for Stage 1 assessment.

If the switchboard does not meet any of the criteria in Stage 1 Table 8a, then assess the switchboard against Table 9a for Stage 2 assessment. Table 9a is more detailed and requires additional information to use including specifics of protection devices and incomer cable details.

Where a switchboard supply is from a sole-use transformer rated  $\leq 315$  kVA or any supply authority owned street mains (District) transformer is unable to be categorised using the criteria specified in Stage 1 Table 8a and Stage 2 Table 9a, the estimation of arc incident energy category can be derived using the Stage 3 curves titled 'Constant Clearing Time' and 'Maximum Corresponding Arc Fault Currents'. The curves 'Constant Clearing Time' are available in Appendix A.13.3 and the curves 'Maximum Corresponding Arc Fault Currents' are available in Appendix A13.4.

A sole-use transformer rated  $\leq 315$  kVA or any supply authority owned street mains (District) transformer switchboards which do not meet the criteria of Stage 1 or Stage 2 or Stage 3 conditions shall be assessed using the full arc flash hazard assessment procedure.

- If the switchboard is a distribution board (described in Condition 2 above) then the PPE category shall be assigned a category in accordance with criteria in Table 8b for Stage 1 assessment or with criteria in Table 9b for Stage 2 assessment.

Distribution switchboards which do not meet the criteria of Stage 1 or Stage 2 shall be assessed using the full arc flash hazard assessment procedure.

### Stage 1 Assessment

Table 8a: Stage 1 Criteria for Arc Incident Energy Levels at Sole Use and Street Main Transformers

| Row Number | Transformer Type        | Switchboard supplied from | CAT 0 PPE<br>(incident energy at 455mm maximum 1.2 cal/cm <sup>2</sup> ; arc flash boundary 455mm) | CAT 1 PPE<br>(incident energy at 455mm maximum 4 cal/cm <sup>2</sup> ; arc flash boundary 950mm)          |
|------------|-------------------------|---------------------------|--|---|
| 1          | Sole Use Transformer    | 315 kVA transformer       | No criteria identified   | Fuse <sup>1</sup> ≤ 200 A and<br>Incomer Cable ≥ 70 mm <sup>2</sup> Cu and<br>Incomer Cable Length ≤ 55 m |
| 2          |                         | 200 kVA transformer       | No criteria identified   | Fuse <sup>1</sup> ≤ 200 A and<br>Incomer Cable ≥ 35 mm <sup>2</sup> Cu and<br>Incomer Cable Length ≤ 10 m |
| 3          |                         | 160 kVA transformer       | No criteria identified   | Fuse ≤ 160 A and<br>Incomer Cable ≥ 35 mm <sup>2</sup> Cu and<br>Incomer Cable Length ≤ 30 m              |
| 4          |                         | 100 kVA transformer       | Fuse ≤ 100 A and<br>Incomer Cable ≥ 16 mm <sup>2</sup> Cu and<br>Incomer Cable Length ≤ 10 m       | Fuse ≤ 150 A and<br>Incomer Cable ≥ 16 mm <sup>2</sup> Cu and<br>Incomer Cable Length ≤ 5 m               |
| 5          |                         | 63 kVA transformer        | Fuse ≤ 100 A and<br>Incomer Cable ≥ 10 mm <sup>2</sup> Cu and<br>Incomer Cable Length ≤ 10 m       | Fuse ≤ 125 A and<br>Incomer Cable ≥ 10 mm <sup>2</sup> Cu and<br>Incomer Cable Length ≤ 5 m               |
| 6          | Street Main Transformer | ≥ 315 kVA transformer     | Fuse ≤ 100 A and<br>Incomer Cable ≥ 25 mm <sup>2</sup> Cu  | No criteria identified  |
| 7          |                         | 200 kVA transformer       | Fuse ≤ 100 A and<br>Incomer Cable ≥ 25 mm <sup>2</sup> Cu  | No criteria identified  |
| 8          |                         | 160 kVA transformer       | Fuse ≤ 100 A and<br>Incomer Cable ≥ 25 mm <sup>2</sup> Cu  | No criteria identified  |
| 9          |                         | 100 kVA transformer       | Not applicable <sup>2</sup>  | Not applicable <sup>2</sup>   |
| 10         |                         | 63 kVA transformer        | Not applicable <sup>2</sup>  | Not applicable <sup>2</sup>   |

Notes:

<sup>1</sup> Fuse size 200A and below will not typically be installed on main incomers supplied by transformers above 160 kVA

<sup>2</sup> Typical street main transformer size is 160 kVA and above

Switchboard Supplied from Upstream Switchboard with its Primary Protection 100A or less

Any switchboard with an incomer protection of 100 A or less shall be assessed using the Stage 1 assessment process. The criteria for the target arc incident energy levels for the switchboards are listed in Table 8b. The criteria used are based on the typical cable size used for the respective fuse sizes.

Table 8b: Stage 1 Incomer protection  $\leq 100A$  criteria for Arc Incident Energy Levels

| Row Number | Switchboard's Incomer Protection | CAT 0  | CAT 1  |
|------------|----------------------------------|--|--------|
| 1          | $\leq 40$ A fuse                 | CAT 0 for all conditions   | -      |
| 2          | 50 A fuse                        | Cable $\geq 10$ mm <sup>2</sup> Cu and Cable Length $\leq 150$ m | Note 1 |
| 3          | 63 A fuse                        | Cable $\geq 16$ mm <sup>2</sup> Cu and Cable Length $\leq 180$ m | Note 1 |
| 4          | 80 A fuse                        | Cable $\geq 16$ mm <sup>2</sup> Cu and Cable Length $\leq 70$ m  | Note 1 |
| 5          | 100 A fuse                       | Cable $\geq 25$ mm <sup>2</sup> Cu and Cable Length $\leq 20$ m  | Note 1 |

Notes:

<sup>1</sup> If CAT 0 requirements are not met, the switchboard is classified as CAT 1

<sup>2</sup> Note that the 2 second rule was applied to the arc flash calculations

## Stage 2 Assessment

Table 9a can be applied to both sole use transformers and street main transformers, unless noted otherwise.

Table 9a: Stage 2 Criteria for Arc Incident Energy Levels Supplied from Transformers at Point of Supply

| Row Number | Switchboard supplied from | CAT 0   | CAT 1  |
|------------|---------------------------|---|--|
| 1          | 315 kVA transformer       | <p>a)<sup>4)</sup> A circuit breaker with short time or instantaneous pickup less than 1.4 kA with delay of 50 ms or less</p> <p>or</p> <p>b)<sup>6)</sup> Fuse size 100 A or smaller</p> | <p>a)<sup>4)</sup> A circuit breaker with short time or instantaneous pickup less than 1.4 kA with delay of 200 ms or less</p> <p>or</p> <p>b) Fuse size of 200 A or smaller with any of the following incomer configurations:</p> <ul style="list-style-type: none"> <li>- A 70 mm<sup>2</sup> Cu incomer cable 55 m or shorter in length;</li> <li>- A 95 mm<sup>2</sup> Cu incomer cable 80 m or shorter in length; or</li> <li>- A 120 mm<sup>2</sup> Cu or larger incomer cable of 105 m or shorter in length</li> </ul>                                    |
| 2          | 200 kVA transformer       | <p>a)<sup>5)</sup> A circuit breaker with short time or instantaneous pickup less than 1.0 kA with delay of 50 ms or less</p> <p>or</p> <p>b)<sup>6)</sup> Fuse size 100 A or smaller</p> | <p>a)<sup>5)</sup> A circuit breaker with short time or instantaneous pickup less than 1.0 kA with delay of 250 ms or less</p> <p>or</p> <p>b) A fuse size of 200 A or smaller provided one of the following incomer configurations:</p> <ul style="list-style-type: none"> <li>- A 35 mm<sup>2</sup> Cu incomer cable 10 m or shorter in length;</li> <li>- A 70 mm<sup>2</sup> to 95 mm<sup>2</sup> Cu incomer cable 30 m or shorter in length; or</li> <li>- A 150 mm<sup>2</sup> to 240 mm<sup>2</sup> Cu incomer cable 55 m or shorter in length</li> </ul> |
| 3          | 160 kVA transformer       | <p>a)<sup>1)</sup> A circuit breaker with short time or instantaneous pickup less than 0.8 kA with delay of 50 ms or less</p>   | <p>a)<sup>1)</sup> A circuit breaker with short time or instantaneous pickup less than 0.8 kA with delay of 250 ms or less</p> <p>b) 160 A fuse, provided one of the following configuration:</p> <ul style="list-style-type: none"> <li>- 35 mm<sup>2</sup> Cu incomer cable with 30 m or less in length; or</li> <li>- 50 mm<sup>2</sup> Cu or larger incomer cable with 55 m or less in length</li> </ul>   |

| Row Number | Switchboard supplied from | CAT 0  | CAT 1   |
|------------|---------------------------|--|---|
| 4          | 100 kVA transformer       | a) <sup>2)</sup> A circuit breaker with short time or instantaneous pickup less than 0.2 kA with delay of 100 ms or less<br><br>b) 80 A fuse, provided one of the following incomer configuration:<br>- 16 mm <sup>2</sup> Cu incomer cable with 105 m or less in length; or<br>- 25 mm <sup>2</sup> Cu incomer cable with 155 m or less in length; or<br>- 35 mm <sup>2</sup> Cu incomer cable with 205 m or less in length; or<br>- 50 mm <sup>2</sup> Cu or larger incomer cable with 305 m or less in length<br>c) 100 A fuse provided one of the following incomer configuration:<br>- 16 mm <sup>2</sup> incomer cable with 55 m or less in length; or<br>- 25 mm <sup>2</sup> Cu incomer cable with 105 m or less in length; or<br>- 35 mm <sup>2</sup> Cu incomer cable with 130 m or less in length; or<br>- 50 mm <sup>2</sup> Cu incomer cable with 180 m or less in length; or<br>- 70 mm <sup>2</sup> Cu or larger incomer cable with 230 m or less in length | a) <sup>2)</sup> A circuit breaker with short time or instantaneous pickup less than 0.2 kA with delay of 400 ms or less<br><br>b) 80 A fuse, provided one of the following incomer configuration:<br>- 16 mm <sup>2</sup> Cu incomer cable with 155 m or less in length; or<br>- 25 mm <sup>2</sup> Cu incomer cable with 230 m or less in length; or<br>- 35 mm <sup>2</sup> Cu or larger incomer cable with 330 m or less in length<br>c) 100 A fuse, provided one of the following incomer configuration:<br>- 16 mm <sup>2</sup> Cu incomer cable with 105 m or less in length; or<br>- 25 mm <sup>2</sup> Cu incomer cable with 180 m or less in length; or<br>- 35 mm <sup>2</sup> Cu incomer cable with 230 m or less in length; or<br>- 50 mm <sup>2</sup> Cu or larger incomer cable with 330 m or less in length<br>d) 150 A fuse, provided one of the following incomer configuration:<br>- 16 mm <sup>2</sup> Cu incomer cable with 5 m or less in length; or<br>- 25 mm <sup>2</sup> Cu to 35 mm <sup>2</sup> incomer cable with 30 m or less in length; or<br>- 50 mm <sup>2</sup> Cu to 70 mm <sup>2</sup> incomer cable with 55 m or less in length; or<br>- 120 mm <sup>2</sup> Cu or larger incomer cable with 105 m or less in length |

| Row Number | Switchboard supplied from | CAT 0   | CAT 1   |
|------------|---------------------------|---|---|
| 5          | 63 kVA transformer        | <p>a)<sup>3)</sup> A circuit breaker with short time or instantaneous pickup less than 0.2 kA with delay of 150 ms or less</p> <p>b) 50 A fuse, provided one of the following incomer configuration:<br/>                     - 10 mm<sup>2</sup> Cu incomer cable with 180 m or less in length; or<br/>                     - 16mm<sup>2</sup> Cu or larger incomer cable with 280 m or less in length</p> <p>c) 63 A fuse, provided one of the following incomer configuration:<br/>                     - 10 mm<sup>2</sup> Cu incomer cable with 130 m or less in length; or<br/>                     - 16 mm<sup>2</sup> Cu incomer cable with 205 m or less in length; or<br/>                     - 25 mm<sup>2</sup> Cu or larger incomer cable with 280 m or less in length</p> <p>d) 80 A fuse, provided one of the following incomer configuration:<br/>                     - 10 mm<sup>2</sup> Cu incomer cable with 55 m or less in length; or<br/>                     - 16 mm<sup>2</sup> Cu incomer cable with 80 m or less in length; or<br/>                     - 25 mm<sup>2</sup> Cu incomer cable with 130 m or less in length; or<br/>                     - 35 mm<sup>2</sup> Cu or larger incomer cable with 180 m or less in length</p> <p>e) 100 A fuse, provided one of the following incomer configuration:<br/>                     - 10 mm<sup>2</sup> to 35 mm<sup>2</sup> Cu incomer cable with 5 m or less in length</p> | <p>a)<sup>3)</sup> A circuit breaker with short time or instantaneous pickup less than 0.2 kA with delay of 600 ms or less</p> <p>b) 50 A fuse or smaller</p> <p>c) 63 A fuse, provided one of the following incomer configuration:<br/>                     - 10 mm<sup>2</sup> Cu incomer cable with 180 m or less in length; or<br/>                     - 16 mm<sup>2</sup> Cu or larger incomer cable with 280 m or less in length.</p> <p>d) 80 A fuse, provided one of the following incomer configuration:<br/>                     - 10 mm<sup>2</sup> Cu incomer cable with 80 m or less in length; or<br/>                     - 16 mm<sup>2</sup> Cu incomer cable with 130 m or less in length; or<br/>                     - 25 mm<sup>2</sup> Cu incomer cable with 230 m or less in length.</p> <p>- 35 mm<sup>2</sup> Cu or larger incomer cable with 280 m or less in length</p> <p>e) 100 A fuse, provided one of the following incomer configuration:<br/>                     - 10 mm<sup>2</sup> Cu incomer cable with 55 m or less in length; or<br/>                     - 16 mm<sup>2</sup> Cu incomer cable with 80 m or less in length; or<br/>                     - 25 mm<sup>2</sup> Cu incomer cable with 130 m or less in length; or<br/>                     - 35 mm<sup>2</sup> Cu or larger incomer cable with 180 m or less in length</p> |

Notes:

- <sup>1)</sup> These settings are only applicable for switchboards supplying motors rated at 75 kW or smaller
- <sup>2)</sup> These settings are only applicable for switchboards supplying motors rated at 55 kW or smaller
- <sup>3)</sup> These settings are only applicable for switchboards supplying motors rated at 37 kW or smaller
- <sup>4)</sup> These settings are only applicable for switchboards supplying motors rated at 100 kW or smaller
- <sup>5)</sup> These settings are only applicable for switchboards supplying motors rated at 70 kW or smaller
- <sup>6)</sup> The fuse size is only applicable for switchboards supplied from street main transformers
- <sup>7)</sup> The delay time used in the table refer to the total arc fault clearing time i.e. protection operating time and a circuit breaker opening time

Any switchboard with an incomer protection of 100 A or less that cannot be assessed using the Stage 1 assessment process based on the rules in Table 8b, the assessment of arc incident energy levels shall be assessed using Stage 2 based on the rules in Table 9b.

These rules are more detailed and require additional data to use such as incomer cable size and length.



Table 9b: Stage 2 Incomer protection  $\leq 100A$  criteria for Arc Incident Energy Levels

| Row Number | Switchboard's Incomer Protection | CAT 0   | CAT 1  |
|------------|----------------------------------|---|--|
| 1          | $\leq 100$ A circuit breaker     | Provided the short time or instantaneous pickup is less than 0.2 kA with delay of 50 ms or less   | Provided the short time or instantaneous pickup is less than 0.2 kA with delay of 250 ms or less |
| 2          | $\leq 40$ A fuse                 | CAT 0 for all conditions  | -  |
| 3          | 50 A fuse                        | <p>Provided one of the following incomer configuration:</p> <ul style="list-style-type: none"> <li>• 10 mm<sup>2</sup> Cu incomer cable with 150 m or less in length; or</li> <li>• 16 mm<sup>2</sup> Cu incomer cable with 240 m or less in length; or</li> <li>• 25 mm<sup>2</sup> Cu or larger incomer cable with 390 m or less in length</li> </ul>   | Note 1   |
| 4          | 63 A fuse                        | <p>Provided one of the following incomer configuration:</p> <ul style="list-style-type: none"> <li>• 16 mm<sup>2</sup> Cu incomer cable with 180 m or less in length; or</li> <li>• 25 mm<sup>2</sup> Cu incomer cable with 280 m or less in length; or</li> <li>• 35 mm<sup>2</sup> Cu or larger incomer cable with 390 m or less in length</li> </ul>   | Note 1   |
| 5          | 80 A fuse                        | <p>Provided one of the following incomer configuration:</p> <ul style="list-style-type: none"> <li>• 16 mm<sup>2</sup> Cu incomer cable with 70 m or less in length; or</li> <li>• 25 mm<sup>2</sup> Cu incomer cable with 110 m or less in length; or</li> <li>• 35 mm<sup>2</sup> Cu incomer cable with 150 m or less in length; or</li> <li>• 50 mm<sup>2</sup> Cu or larger incomer cable with 200 m or less in length</li> </ul> | Note 1   |
| 6          | 100 A fuse                       | <p>Provided one of the following incomer configuration:</p> <ul style="list-style-type: none"> <li>• 25 mm<sup>2</sup> Cu incomer cable with 20 m or less in length; or</li> <li>• 35 mm<sup>2</sup> Cu incomer cable with 30 m or less in length; or</li> <li>• 50 mm<sup>2</sup> Cu or larger incomer cable with 40 m or less in length</li> </ul>  | Note 1   |

Notes:

<sup>1</sup> If CAT 0 requirements are not met, the switchboard is classified as CAT 1

<sup>2</sup> The delay time used in the table refer to the total arc fault clearing time i.e. protection operating time and a circuit breaker opening time

### Stage 3 Assessment

Where a switchboard supplied from a sole-use transformer rated  $\leq 315$  kVA or any supply utility owned street mains transformer is unable to be categorised using the criteria specified in Table 8a and Table 9a, the estimation of arc incident energy category can be derived using the curves titled ‘Constant Clearing Time’ and ‘Maximum Corresponding Arc Fault Currents’.

The curves ‘Constant Clearing Time’ are available in Appendix A13.3 and the curves ‘Maximum Corresponding Arc Fault Currents’ is available in Appendix A13.4. The arc incident energy estimation steps are as below:

- Step 1: Calculate bolted minimum and maximum three-phase short-circuit current at the switchboard using IEC 60909 method
- Step 2: Calculate minimum arcing current using the minimum bolted fault currents using curve in Appendix A13.4
- Step 3: Estimate and confirm the short-time/instantaneous protection (definite-time curve with  $I^2t=OFF$ ) for the circuit breaker pickup is less than the corresponding minimum arcing fault current (to confirm that the circuit breaker will pick up the minimum arcing current)
- Step 4: Calculate total arc energy clearing time (i.e. short-time/instantaneous protection operating time and circuit breaker opening time)
- Step 5: Identify the transformer size applicable to the switchboard and select the applicable curve ‘Constant Clearing Time’ from Appendix A 13.3
- Step 6: Estimate the arc incident energy from the selected curve ‘Constant Clearing Time’ corresponding to ‘arc energy clearing time’ and ‘bolted fault current’. The maximum value of bolted fault current should be used as ‘bolted fault current’

Refer to Appendix A13.5 for an example.

## 10 Arc Flash Mitigation

Both new and existing installations to be modified shall be designed to limit a worker’s exposure to arc flash incident energy levels of no more than Category 1, so far as is reasonably practicable. Possible engineering measures for consideration by the designer are described in Section 10.1 to Section 10.8.

For line-side and busbar energy reduction process refer to flowcharts at Appendix 13.6.

*Note: The Designer shall investigate, as a matter of due diligence, if there is any reasonable, inexpensive and efficient measure that can be easily taken to minimise the let through energy to lower than Category 1 (i.e. Cat 0). If this is the case then this must be pursued and/or implemented.*

### 10.1 Protection Device Selection and Setting Optimisation

Arc flash incident energy can be greatly reduced by selecting appropriate protection devices and protection settings.

Setting optimisation is achieved by reducing the protection settings as much as possible, while maintaining time and current coordination between protection devices.

There is usually a trade-off between protection grading and arc flash hazard reduction, and frequently reductions in arc flash incident energy levels cannot be achieved through protection optimisation without causing malgrading.

Introducing an instantaneous element on a switchboard’s main protection will usually result in malgrading with downstream devices. Instead of adjusting the instantaneous protection the most effective approach is often to increase protection sensitivity by adjusting, in combination, the long-time delay, short-time pickup and short-time delay.

A switchboard's incoming protection can only be relied upon to achieve the desired Category 1 rating where line side terminals are fully insulated or phase barriered. Otherwise the Category must be based on the next upstream protection device.

New boards are required to have line side insulation, as per the current DS26 switchboard type specifications. On existing boards being modified, if practical, fully insulating the line side terminals shall be included within the scope of work, allowing the incomer protection to be relied upon.

Where the incomer device is rackable (except for rackable moulded case circuit breakers), there is a risk of a fault on the line side during racking even when the line side conductors are insulated. Therefore, for racking of the incomer the possible incident energy exposure levels shall be calculated based on the trip time of the backup protection. The incident energy limits under the incomer racking scenario may be increased to Category 2, where practicable, to allow for the slower acting backup protection.

## 10.2 Protection device specification

For new installations, where fuses or circuit breakers with a limited of fixed setting range would normally be used, if there is a potential benefit of improving setting optimisation consider specifying circuit breakers with improved setting adjustment. (where using circuit breakers instead of fuses is allowed by supply utility and other requirements).

## 10.3 Switchboard Design Considerations

Switchboards which are arc fault containment tested (as described previously in Section 7.2) will limit a worker's exposure to arc flash incident energy levels to Category 0 provided that energy levels are within the tested capabilities of the switchboard.

Water Corporation's type specification for large switchboards DS26-17 requires boards to be arc fault containment tested to values as stated in the specification.

If the protection clearance time exceeds a board's rated arc duration, where practicable, the protection shall be adjusted to reduce the clearance time below the rated duration. If this is not achievable then an 'energy rating' for the switchboard shall be estimated by calculating the ' $I^2t$ ' value based on the board's tested arc fault current and duration values. This assessed 'energy rating' shall then be compared against the arcing fault ' $I^2t$ ' value. If the 'energy rating' of the board is greater than the arcing fault ' $I^2t$ ' value then PPE requirements shall be discounted to Cat 0 (for door's closed) as describe in Section 7. Otherwise other engineering mitigations shall be implemented to reduce the arcing fault ' $I^2t$ ' value below the 'energy rating' so that the incident energy is less than the 'energy rating' of the switchboard.

### Note

*This method of extrapolating a switchboard's 'energy rating' can only be used if the arc flash duration exceeds a board's rated arc duration. The method shall not be used where the prospective arc fault current exceeds the board's arc fault current rating.*

## 10.4 Arc Fault Current Limiting

Arc fault current limiting shall be installed on the feeders to switchboards which are not used for power distribution such as soft starters, variable speed drives, direct online motor starting cubicles, and power factor correction cubicles.

Either current limiting fuses or moulded case circuit breakers can be used. The design shall ensure that the protection device specified will operate in its fault current limiting range under minimum arcing fault current conditions.

The performance of fuses for limiting the peak value of prospective bolted fault current is generally better than that of fault current limiting circuit breakers. Thus, in situations where the prospective bolted fault current exceeds the withstand rating of equipment the peak let-through fault current of the fuse or circuit breaker must not exceed the withstand rating of the protected equipment.

## 10.5 Arc Flash Detection

For switchboards without arc flash containment tests and where the overcurrent protection or the application of fault current limiting devices does not reduce the arc flash energy levels to Category 1 or below, then an arc flash detection system shall be installed.

Water Corporation's type specification for large switchboards, DS26-17, includes a requirement for arc flash detection.

Water Corporation's 100A, 220A and 440A switchboards include an optional requirement for arc flash detection.

Arc flash detection systems shall combine two independent measures (light and current) to detect an arcing fault. However, for 100A, 220A and 440A switchboards, the arc flash detection system shall use light only.

The current pickup setting of the relay shall be greater than the largest motor inrush current or the switchboard incomer rating, whichever is the greatest, and less than 85% of the minimum calculated arc fault current. A setting midpoint between the two outer limits is recommended as initial set-up. In any case, the setting shall not exceed 85% of the minimum calculated arc fault.

The AFD response time to initiate tripping of the protection device is 20 milliseconds allowing for a possible interface relay.

Arc flash detection current transformers (CTs) shall be located on the line side of the incomer protection device. If practical the preferred location of line side CTs is at the upstream remote outgoing cable feeder panel, and the preferred tripping location is at the upstream remote feeder circuit breaker.

If this is not possible or practical then as described in Clause 10.1 line side insulation is required to prevent the fault occurring upstream of the incomer protection and CTs.

Arc light sensors shall be readily accessible for maintenance.

The trip signal to the upstream circuit breaker trip coil shall be of the pulse type (i.e. not maintained).

## 10.6 Arc Quenching

Arc quenching devices can be used in conjunction with an arc flash detection system to clear an arcing fault within a few milliseconds. An arc flash quenching device extinguish an arc much faster than a circuit breaker can by causing a rapid bolted short circuit between phases or between phases and earth close to the arcing fault location. This causes a collapse in the arc voltage rapidly extinguishing the arc. The bolted short circuit current flows through the quenching device until it is interrupted by the primary protection fuse or circuit breaker.

Arc quenching devices are available for both HV and LV switchboards. For LV switchboards the available quenching devices are relatively compact and can be incorporated into the switchboard being protected, if the fault (bolted) withstand rating of the board is adequate. If the board cannot safely sustain a bolted fault then the quenching point can be installed upstream of the board.

Typically HV quenching systems need to be installed within a separate standalone cubicle.

A benefit of an arc quenching device is that it can operate effectively without the need for a shunt trippable circuit breaker. This means that the device can be fitted to fuse protected boards without having to retrofit a circuit breaker.

## 10.7 Zone Selective Interlocking

Zone selective interlocking between backup, primary and outgoing feeder protection is an alternative to installing an arc flash detection system to reduce incident energy levels.

Zone selective interlocking uses blocking signals which are sent between downstream and upstream protection devices, allowing protection to trip more quickly without a protection grading trade off.

## 10.8 Remote Switching

Remote tripping, closing and spring charging reduces exposure levels by allowing workers to undertake switching operations from a control panel located at a safe distance from the board. Where the mitigation methods described in Clause 10.1 to 10.7 do not reduce incident energy levels to Category 1 or below then remote switching of HV circuit breakers and LV ACB incomers and feeders shall be implemented as an additional feature.

A label shall be installed adjacent to the device to indicate remote switching is available.

DS21 requires remote switching to be installed on incomer to HV and LV switchboards fed from or feeding to transformers of 315kVA or higher.

## 11 Documenting Assessment Results and Deliverables

The results of the arc flash assessments shall be described in the engineering design report covering:

- The different modes of operation, and the worst case scenario (Clause 6.7.1 and 6.13)
- Summary of the worst case scenario calculation results including the arc flash boundary, the working distance, incident energy category at the working distance, the arc flash safety in design approach and outcomes. Where calculations are not required, as per Section 9, only the PPE category is required. The basis of selection for the PPE Category shall be described.
- A summary of arc flash PPE categories for the applicable activities identified in Table 7.
- An arc flash warning label/s (Section 8)

A detailed calculation sheet or system study output for the worst calculation shall be provided including:

- Bolted fault level on the bus
- Bolted fault level for each contributing branch and the corresponding arcing fault current
- Clearance time for each contributing branch
- The bus gap
- The working distance
- The incident energy at the working distance
- The arc flash boundary

The PTW model shall be included as a deliverable along with any associated libraries and other reference files. Modelling files must be saved in Document Management System by the Water Corporation Design Manager. The model shall capture the maximum and minimum fault level modes of operation as separate operational scenarios.

The results of the arc flash assessment shall be documented on the engineering design summary or primary design drawings (bundle '40', Protection Grading) in tabular format with all information necessary for the production of the label as per the requirements of this standard). Details presented on the drawings shall be:

- The PPE category and the incident energy at the working distance for a fault occurring on the busbars – Location 2
- If the line side conductors are susceptible to an arcing fault, i.e. incomer racking or line side conductors not insulated or phase barriered, then the PPE category and the incident energy at the working distance shall also be shown for a fault occurring at Location 1
- The switchboard arc flash warning label details compatible with the information requirements described on the template label in Section 8
- The calculated arcing fault currents as shown in Figure 6 (clause 6.13) highlighting the arc fault current relating to the highest incident energy selected

- If the shorthand method is used (Tables 8a/8b/Stage 3 or 9a/9b are utilised), rather than a full calculation, the basis of selection and reference to the relevant table shall be stated on the Protection Grading drawing in lieu of the tabular format
- Current pickup setting for the relay and any other critical settings
- A note shall be added on the protection grading drawing and a label added below the arc flash warning label on the switchboard as follows:

**‘No changes to the protection grading settings without reference to the designer’.**

## 12 Change Control

Changes to the switchboard type, protection devices and settings or changes affecting the fault levels at the board will affect the arc flash incident energy levels. If these changes occur after the final engineer design has been submitted, the arc flash energy levels shall be re-assessed.

Similarly, changes to the existing switchboards on site shall be assessed for arc flash hazard in accordance with the requirements of this standard.

Where changes are found necessary, documentation and labels for the switchboard shall be produced detailing the revised condition and requirements as per Clause 11 of this standard.

## 13 Appendix A – HV and LV Worked Examples

This appendix uses two worked examples to illustrate the concepts and procedures of DS 29, *Arc Flash Hazard Assessment of Switchgear Assemblies*.

The two worked examples include a small and a large installation. The large installation includes an HV and LV switchboard. Model development, arc flash calculations, warning labels, and possible arc flash mitigation measures are demonstrated in detail.

The examples cover manual ‘hand-calculations’, software-assisted calculations (using Power\*Tools for Windows) and the shorthand method (Stage 1, 2 and 3 assessments) as presented in Section 9.

Particular guidance is given on the PTW study setup options and common pit-falls.

# 13.1 Large installation

Consider the arrangement of equipment illustrated below.

It is required to find the arc fault incident energy on the 22kV switchboard and the 415V MCC's.

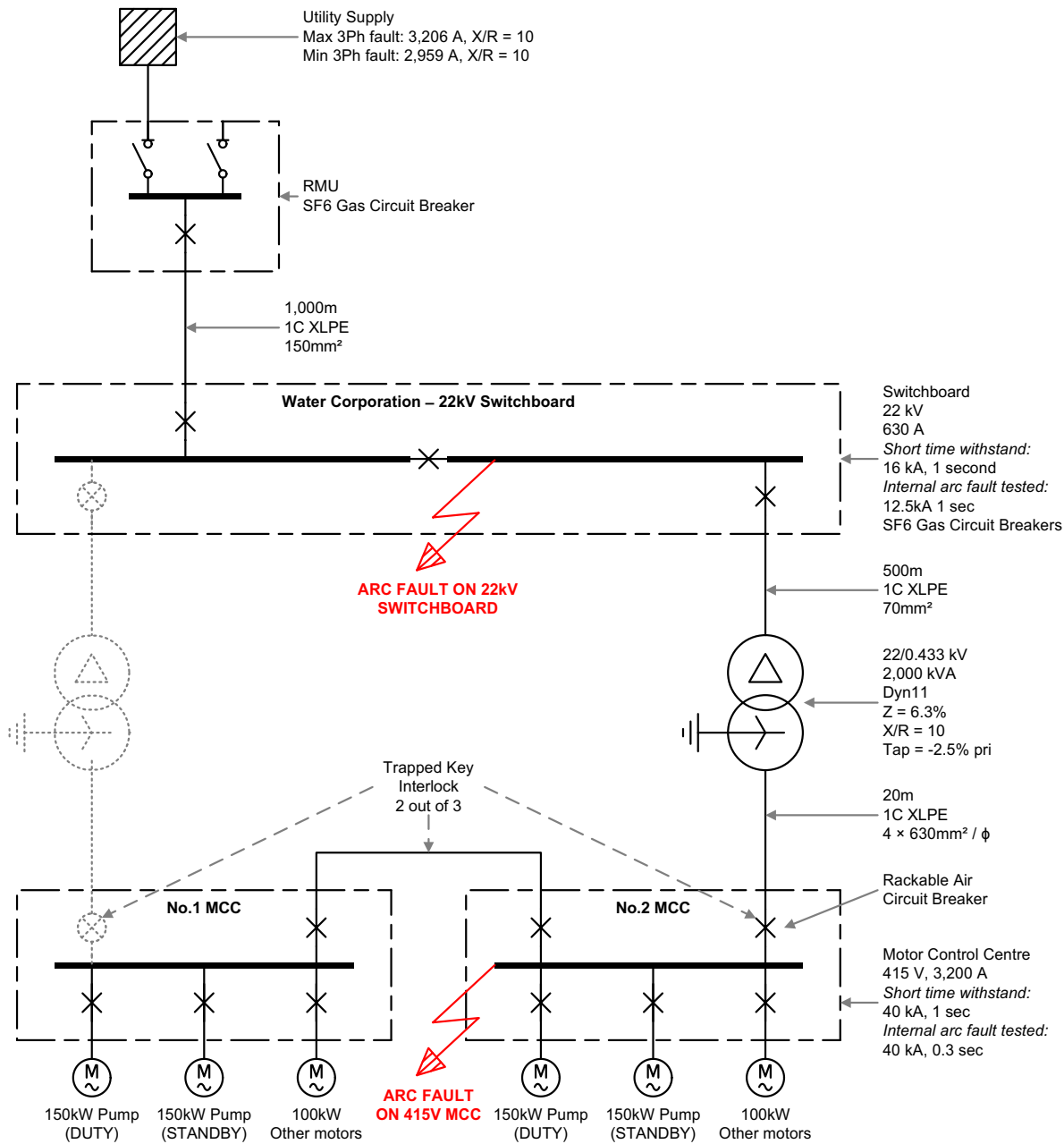

Example Figure 9: Power system single line diagram and input data

## 13.1.1 Model Development and Bolted Fault Calculations

### Collect data

The following data is collected, as per DS 29 Clause 6.5, *Collecting the System and Installation Data*:

- Utility fault contributions – three-phase minimum and maximum
- Transformer parameters – nominal HV and LV voltage, vector group, impedance, X/R ratio, tapping
- HV and LV cable parameters – type, size, length, number of cables per phase
- Switching point status – switches open or closed. In this example, the LV MCC incomers and bus-tie have a trapped-key interlock, so the transformers cannot be in parallel.
- Motor details including nameplate size, locked-rotor/full-load current ratio, power factor, and efficiency
- Protection relay settings

### Build model

Once the data is collected, the system is modelled into Power Tools for Windows (PTW).

### Perform bolted fault calculations

Power\*Tools is used to calculate the bolted fault currents. The bolted fault current is calculated using the IEC 60909 / AS 3851 calculation method. The values calculated are three-phase, initial symmetric, r.m.s. currents,  $I_k''$  (kA).

The calculation includes both the busbar total fault current, and the individual branch contributions.

The figures below illustrate:

- PTW model, with maximum fault levels (Example Figure 11).  
Pre-fault voltage factors  $c_{\max} = 1.10$  for HV, and  $c_{\max} = 1.06$  for LV, are applied.  
The grid infeed is modelled with the maximum fault contribution, as quoted by the utility.
- PTW model, with minimum fault levels (Example Figure 12)  
Pre-fault voltage factors  $c_{\min} = 0.90$  for HV, and  $c_{\min} = 0.94$  for LV, are applied.  
The grid infeed is modelled with the minimum fault contribution from the utility.
- Protection device time current curves – for LV protection (Example Figure 13)
- Protection device time current curves – for HV protection (Example Figure Figure 14)

### Multiple modes of operation

If different switching configurations ('modes of operation') are possible, then the switching scenarios, i.e. open or closed positions of switches, must be considered.

This is because the arcing fault current may vary significantly when different current paths are open or closed.

Consider the following:

- Multiple grid infeeds
- Parallel cable feeders
- Parallel transformers
- Bus section switches
- Emergency supplies
- Key interlocking which may restrict how the plant is switched



An example of minimum and maximum switching scenarios is shown below.

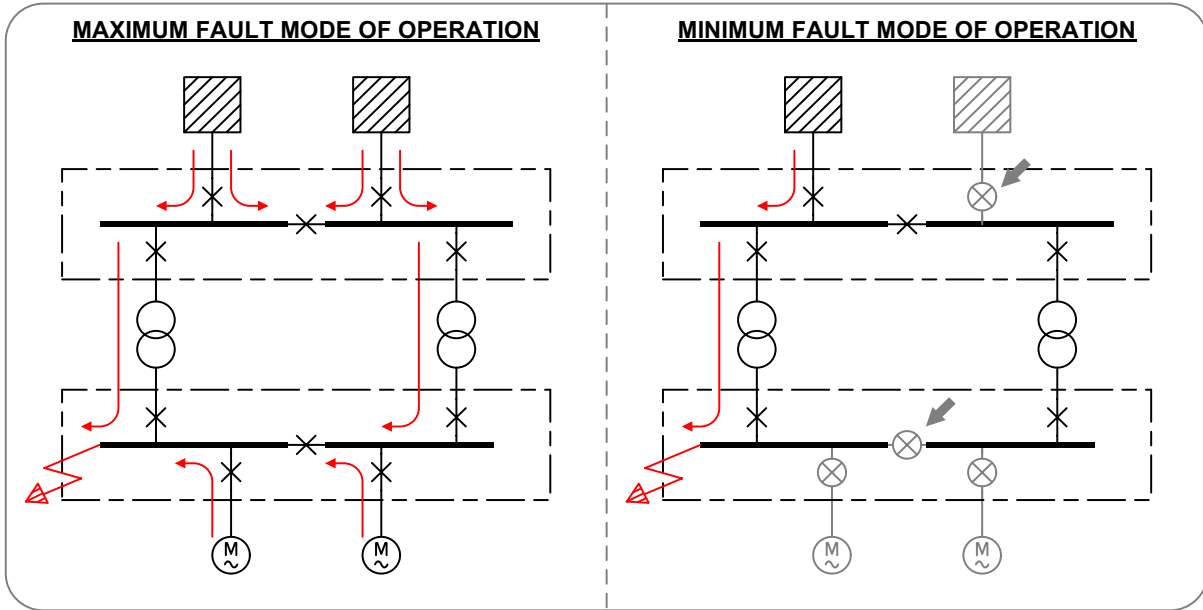

Example Figure 10: Maximum and minimum switching scenarios.

In the example of Example Figure 9 there is only one grid infeed, and a key interlock prevents the transformers from operating in parallel.

Therefore there is no need to consider a separate ‘minimum fault’ switching scenario.

It suffices to run a second fault study with ‘minimum pre-fault voltages’ as per DS29 Section 6.7, *Determine the Bolted Fault Current*, Table 1.

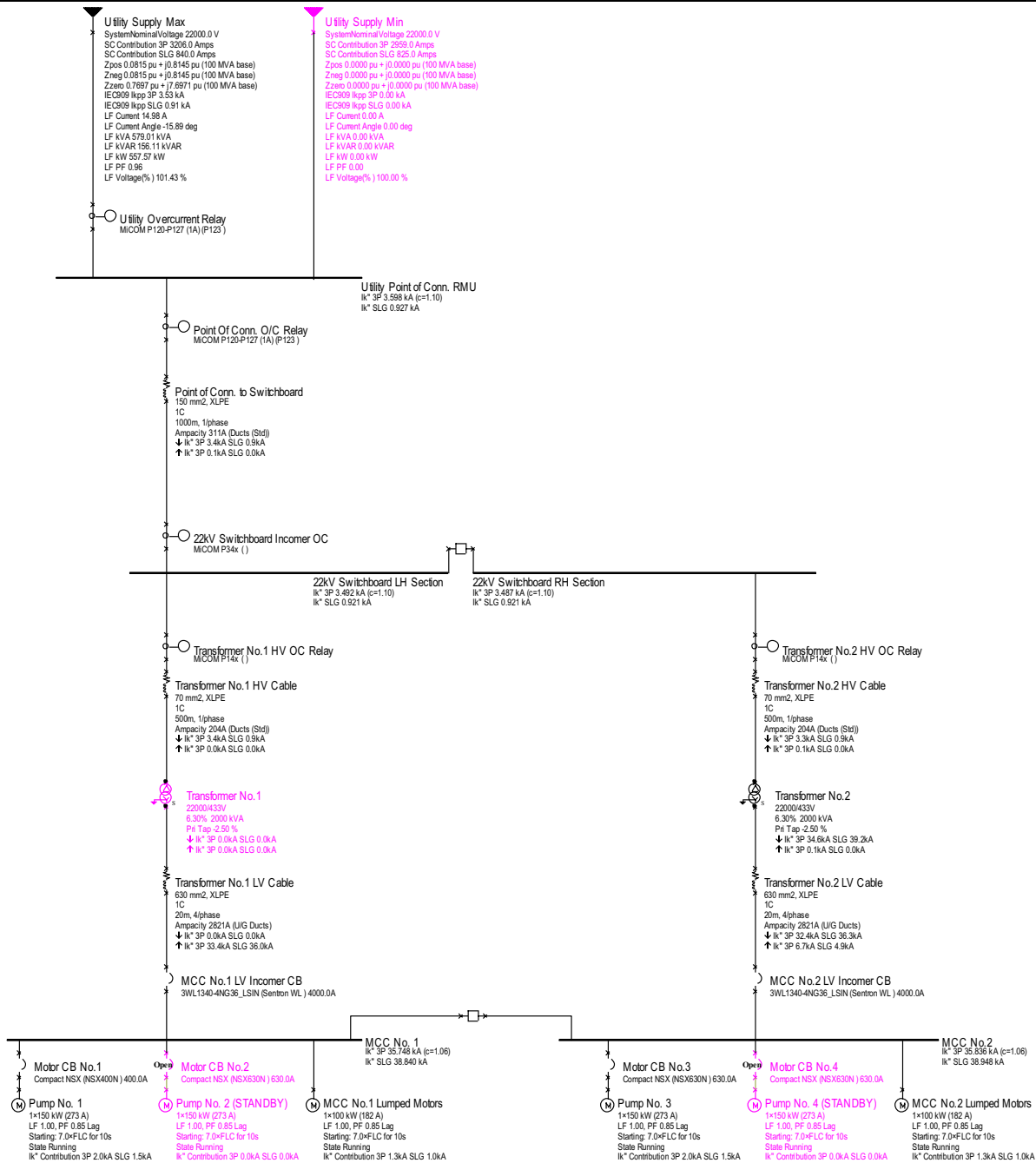

Example Figure 11: “Maximum Fault” PTW Model of Power System, including IEC 60909 Fault Current Calculations

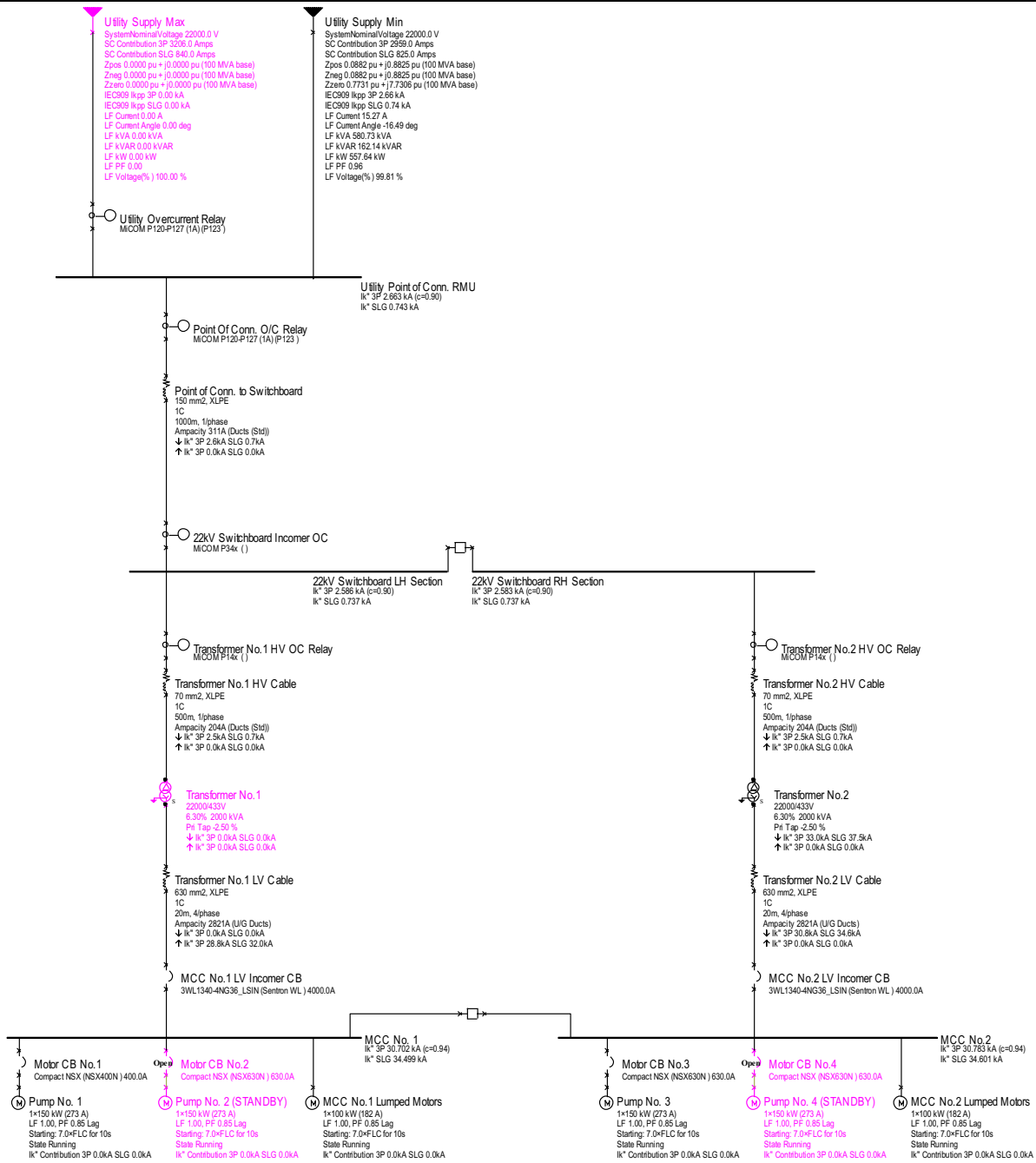

Example Figure 12: “Minimum Fault” PTW Model of Power System, including IEC 60909 Fault Current Calculations

CURRENT IN AMPERES

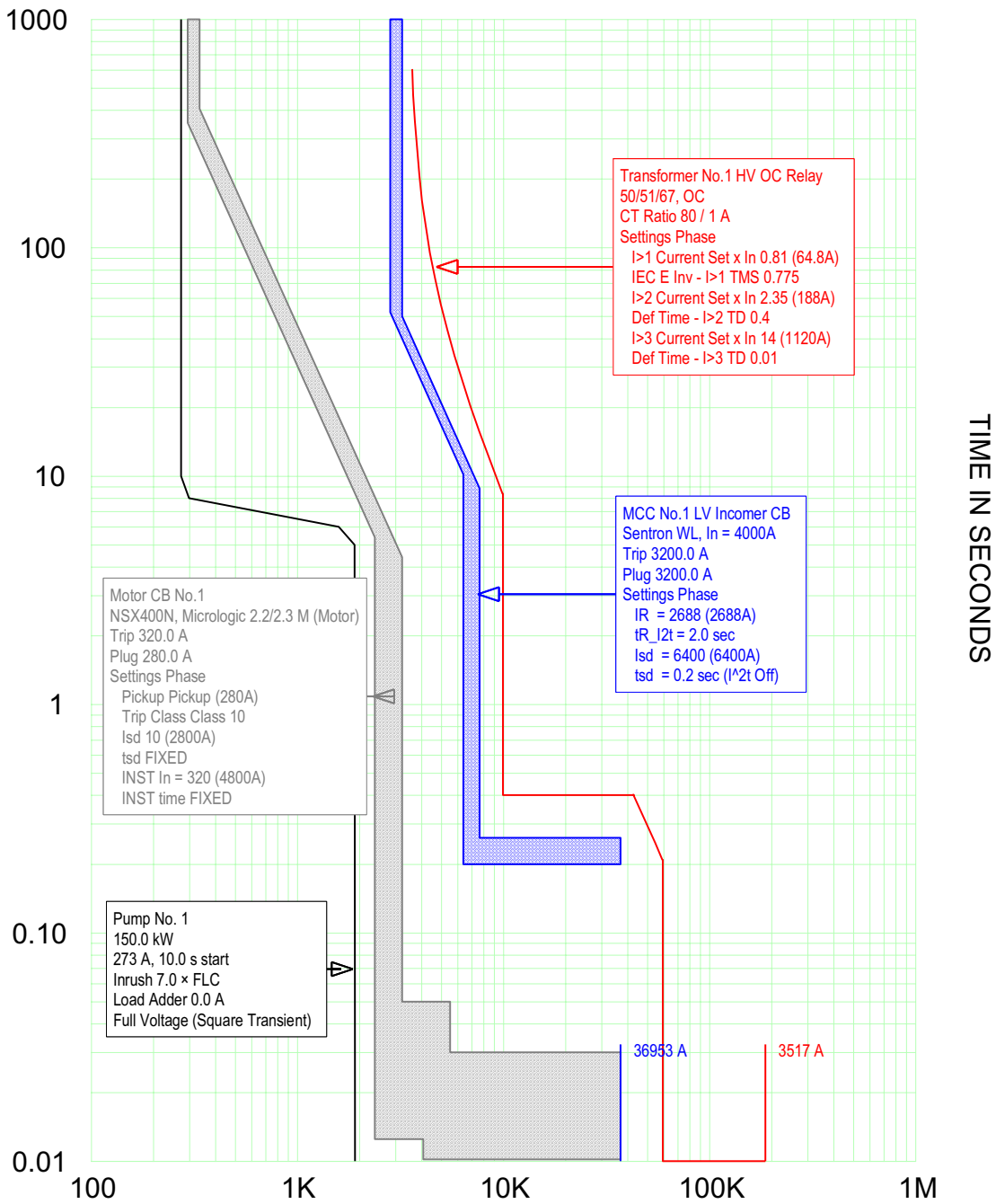

MCC.tcc Ref. Voltage: 415V  
Current in Amps x 1 @415 V x 0.019 @22 kV  
Bus Fault Current (IEC909 Ikpp 3P)

Example Figure 13: LV Protection Settings

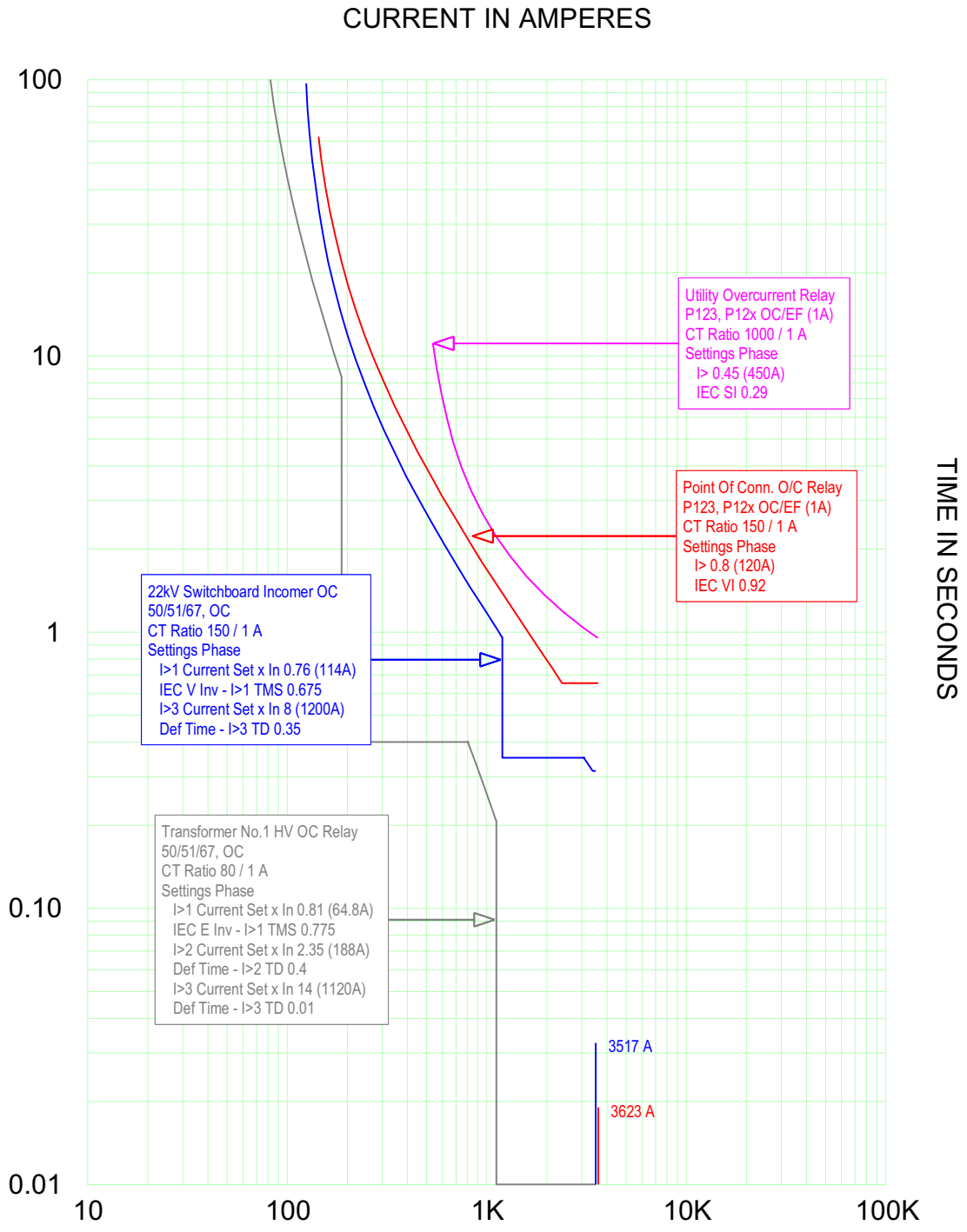

HV.tcc Ref. Voltage: 22000V  
Current in Amps x 1 @22 kV  
Bus Fault Current (IEC909 Ikpp 3P)

Example Figure 14: HV Protection Settings

### 13.1.2 Low Voltage MCC

It is desired to calculate the arc flash incident energy for a fault on the LV motor control centre.

In this example, incident energy calculations are required for two fault locations:

1. Arc fault occurring on the MCC busbar – at 'Location 2'.
2. Arc fault occurring on the line-side of the incomer ACB – at 'Location 1'.

This is required because the incomer ACB is rackable – a line side fault might occur while racking.

The calculations must cover all combinations of:

- Minimum and maximum bolted-fault current
- 100% arcing current and 85% arcing current

Eight calculations are required in total. The results of these calculations are shown in the table below.

Example Table 10: LV MCC – Incident Energy Calculations

| Fault location                          | Switching Scenario | Arc Fault             | Busbar Arcing Fault Current (kA) | Incident Energy (cal/cm <sup>2</sup> ) |
|---|--------------------|-----------------------|----------------------------------|--|
| Busbar Fault<br>"Location 2"            | Maximum fault      | 100% I <sub>arc</sub> | <b>15.78 kA</b>                  | <b>12.3 cal/cm<sup>2</sup></b>         |
|   |                    | 85% I <sub>arc</sub>  | 13.41 kA                         | 10.4 cal/cm <sup>2</sup>               |
|   | Minimum fault      | 100% I <sub>arc</sub> | 13.98 kA                         | 12.1 cal/cm <sup>2</sup>               |
|   |                    | 85% I <sub>arc</sub>  | 11.88 kA                         | 17.4 cal/cm <sup>2</sup>               |
| Incomer line-side fault<br>"Location 1" | Maximum fault      | 100% I <sub>arc</sub> | 15.78 kA                         | 20.7 cal/cm <sup>2</sup>               |
|   |                    | 85% I <sub>arc</sub>  | 13.41 kA                         | 17.4 cal/cm <sup>2</sup>               |
|   | Minimum fault      | 100% I <sub>arc</sub> | <b>13.98 kA</b>                  | <b>21.0 cal/cm<sup>2</sup></b>         |
|   |                    | 85% I <sub>arc</sub>  | 11.88 kA                         | 17.6 cal/cm <sup>2</sup>               |

The calculation for Busbar Fault (Location 2) – Maximum Fault – 100% I<sub>arc</sub> is detailed below.

### 13.1.2.1 Example Calculation

#### **Bolted Fault Current**

From the PTW calculation results:

- Bus-bar bolted fault current: 36,000 A

There are two branch contributions:

- 32,400 A from supply transformer. (83% of total)
- 6,600 A from induction motors. (17% of total)

Note: 32,400 A + 6,600 A = 39,000 A which does not add to 36,000 A.

The discrepancy is due to the different X/R ratios of the transformer contribution vs. the motor fault contributions. We are only interested in the ratio of the branch currents, not their absolute value, so this does not affect the calculations.

#### **Bolted Fault Current → Arcing Fault Current**

Use this information to convert the bolted fault current to the arcing fault current. Since the nominal voltage is < 1,000 V, use IEEE Std 1584 formula (1):

$$\log_{10}(I_a) = K + 0.662 \log_{10}(I_{bf}) + 0.0966 V + 0.000526 G + 0.5588 V \cdot \log_{10}(I_{bf}) - 0.00304 G \cdot \log_{10}(I_{bf})$$

The parameters for the calculation are:

|          |      |  |
|----------|------|--|
| $I_a$    | [kA] | The arcing current   |
| K        |      | -0.097 for box configuration   |
| $I_{bf}$ | [kA] | 36 kA – from IEC 60909 fault calculation   |
| V        | [kV] | 0.415 kV – nominal voltage of MCC  |
| G        | [mm] | 32 mm – busbar gap for LV MCC<br>(Refer DS29 Clause 6.8, <i>Determining Bus Gaps</i> ) |

With these parameters, the formula gives the arcing fault current as  $I_a = 15.8$  kA.

**Arc fault duration**

$I_a = 15.8$  kA is the total busbar arc fault current.

To determine the protection operating time, it is required to calculate how much of this current is seen by the protection device.

Recall that the branch fault contributions were – 83% from the system supply, and 17% from motor contribution.

Therefore, the 15.8 kA arcing current is broken into:

- System supply:  $83\% \times 15.8$  kA = 13.1 kA
- Motor contributions:  $17\% \times 15.8$  kA = 2.7 kA

The MCC incomer circuit breaker will detect the 13.1kA component. Referring to the time current curves, Example Figure 13, the clearing time for this fault current will be **260 milliseconds**. This includes 200 ms tripping time, and 60ms circuit breaker opening time.

**Arc fault incident energy**

Use IEEE 1584 formulas (4), (5), and (6) to calculate the arc fault incident energy.

---

Eq (4):  $\log_{10}(E_n) = K_1 + K_2 + 1.081 \log_{10}(I_a) + 0.0011 G$

---

Eq (5):  $E_n = 10^{[\log_{10} E_n]}$

---

Eq (6):  $E = 4.184 \times C_f \cdot E_n \left(\frac{t}{0.2}\right) \left(\frac{610^x}{D^x}\right)$

---

The parameters for these equations are:

|       |                      |   |
|-------|----------------------|---|
| $I_a$ | [kA]                 | The arcing current                        |
| G     | [mm]                 | 32 mm – busbar gap for LV MCC             |
| $K_1$ |                      | -0.555 for enclosed equipment             |
| $K_2$ |                      | -0.113 for effectively earthed system     |
| $E_n$ | [J/cm <sup>2</sup> ] | Incident energy in 'normalised form'      |
| E     | [J/cm <sup>2</sup> ] | Incident energy                           |
| $C_f$ |                      | 1.5 for voltages $\leq$ 1kV               |
| t     | [sec]                | Arcing duration                           |
| D     | [mm]                 | 455mm – Working distance for LV equipment |
| x     |                      | 1.473 – Distance exponent for LV MCC      |



There are two sources of fault current, which clear at different times. The motor fault contribution of 2.7 kA clears in 100 ms; the main incomer contribution of 13.1 kA clears in 260 ms. Therefore two incident energy calculations are done:

- $I_a = 13.1 \text{ kA} + 2.7 \text{ kA} = 15.8 \text{ kA}$   
 $t = 100 \text{ ms}$   
 $\rightarrow E = 22.2 \text{ J/cm}^2 = 5.3 \text{ cal/cm}^2$
- $I_a = 13.1 \text{ kA}$   
 $T = 260 - 100 \text{ ms} = 160 \text{ ms}$   
 $\rightarrow E = 29.0 \text{ J/cm}^2 = 6.9 \text{ cal/cm}^2$

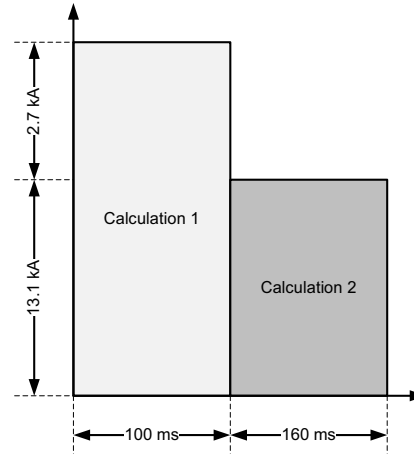

The total incident energy is the sum of these parts:

$$E = 5.3 \text{ cal/cm}^2 + 6.9 \text{ cal/cm}^2 = \underline{\underline{12.2 \text{ cal/cm}^2}}$$

### Arc flash boundary

The arc flash boundary is found by solving IEEE 1584 equation (8):

$$D_B = \left[ 4.184 \times C_f \cdot E_n \left( \frac{t}{0.2} \right) \left( \frac{610^x}{E_B} \right) \right]^{\frac{1}{x}}$$

Substituting  $E_n$  from Equation (6) this simplifies to:

$$D_B = D \times \left( \frac{E}{E_B} \right)^{\frac{1}{x}}$$

Where:

- E is the incident energy
- D is the working distance [mm]
- $D_B$  is the arc flash boundary [mm]
- $E_B$  is 5 J/cm<sup>2</sup> or 1.2 cal/cm<sup>2</sup>.

For this example,

$$D_B = 455 \text{ mm} \times \left( \frac{12.2 \text{ cal. cm}^{-2} \cdot 4.184 \text{ J. cal}^{-1}}{5 \text{ J. cm}^{-2}} \right)^{\frac{1}{1.473}} = 2,202 \text{ mm}$$

At a distance of 2.2 metres, the incident energy has fallen to 1.2 cal/cm<sup>2</sup>.

---

### 13.1.2.2 Calculations for other cases

The other results in Example Table 10 were calculated as follows.

- For the 85% arc fault current calculations, the arcing current  $I_a$  was multiplied by 0.85
- The example calculation above was for maximum fault switching scenario, using the data from Example Figure 9.

For minimum fault switching scenario, data from Example Figure 12, was used

- The example calculation above was for a busbar fault, at 'Location 2'. These faults would be cleared by the incomer ACB in 260 ms

For faults on the line side of the incomer, at 'Location 1', the faults are cleared by the backup protection – the 22kV transformer protection relay. From Example Figure 13, the tripping time would be 400 ms for all arc fault currents being considered. An additional 50 ms is added for SF6 CB opening time.

### 13.1.2.3 Determine required PPE level and generate warning label

From the results in Example Table 10 we conclude:

- Busbar faults: The worst case incident energy is 12.3 cal/cm<sup>2</sup>. This is in arc flash PPE Category 3 (8 – 25 cal/cm<sup>2</sup>.)
- Line-side faults: The worst case incident energy is 21.0 cal/cm<sup>2</sup>. This is more than the incident energy for a busbar fault. However, it is still in the range of Category 3

Based on this information, the warning label is generated, following DS29 Clause 8, *Producing Arc Flash Warning Labels*.

The PPE categories are filled in as per DS29 Clause 7.4, *Operational Activities*, Table 7.

Note that this switchboard is arc-fault contained (see Example Figure 9). Therefore the PPE category with doors closed is Category 0, so long as the arcing fault current and duration is less than the arcing fault type test values.

- The switchboard arc fault rating is 40 kA, 0.3 seconds
- For busbar faults, the arc fault is 15.8 kA for 0.26 seconds
- For incomer faults, the arc fault is up to 15.78 kA for 0.45 seconds. This violates the arc fault type test duration

However, the energy, expressed as A<sup>2</sup>.sec, is only  $1.12 \times 10^8$  [A<sup>2</sup>.sec]

The board rating is  $4.8 \times 10^8$  [A<sup>2</sup>.sec]

The arc fault energy is less than the board’s arc fault rating, therefore Category 0 still applies.

**DATE: MAY 2016**

**JAMES COOK DR. PUMPING STN.  
EXAMPLE LV MCC**

| ACTIVITY                                 | Minimum PPE Category |             |
|--|----------------------|-------------|
|  | Door Open            | Door Closed |
| <b>INCOMER</b>                           |                      |             |
| Racking                                  | CAT 3                | CAT 0       |
| Switching                                | CAT 3                | CAT 0       |
| <b>NON-INCOMER CIRCUITS</b>              |                      |             |
| Switching or Racking                     | CAT 3                | CAT 0       |
| Live Electrical Testing (Power Circuits) | CAT 3                | N/A         |
| Operating Controls                       | CAT 3                | CAT 0       |
| Visual Inspection (Live Parts)           | CAT 3                | CAT 0       |

**ARC FLASH HAZARD**  
415VAC Shock Hazard

Figure 15: Example Arc Flash Label

---

### 13.1.2.4 Safety in Design/Arc Flash Mitigation

The existing protection settings shown in Example Figure 13 and Example Figure 14 can be changed to reduce the arc fault duration on the MCC.

- Reduce LV incomer ACB short-time delay setting, from 200 ms to 80 ms

Accounting for the 60ms ACB tripping time, this primary protection clearing time from 260 ms to 140 ms.

The incident energy for a busbar fault, 'Location 2', is reduced from 12.3 cal/cm<sup>2</sup> (Category 3) to 7.1 cal/cm<sup>2</sup> (Category 2)

- Reduce HV transformer protection relay, O/C setting, I>> delay, from 400 ms to 300 ms

Accounting for 50ms CB opening time, this reduces backup protection clearing time from 450ms to 350ms

The incident energy for an incomer line-side fault, 'Location 1', is reduced from 21.0 cal/cm<sup>2</sup> (Category 3) to 16.3 cal/cm<sup>2</sup> (Category 3)

The revised protection settings are illustrated in Example Figure 16. The revised settings maintain full protection co-ordination with adequate grading margins.

The arc fault hazard could also be reduced using any of the engineering mitigations listed under DS29 Clause 10, *Arc Flash Mitigation*.

CURRENT IN AMPERES

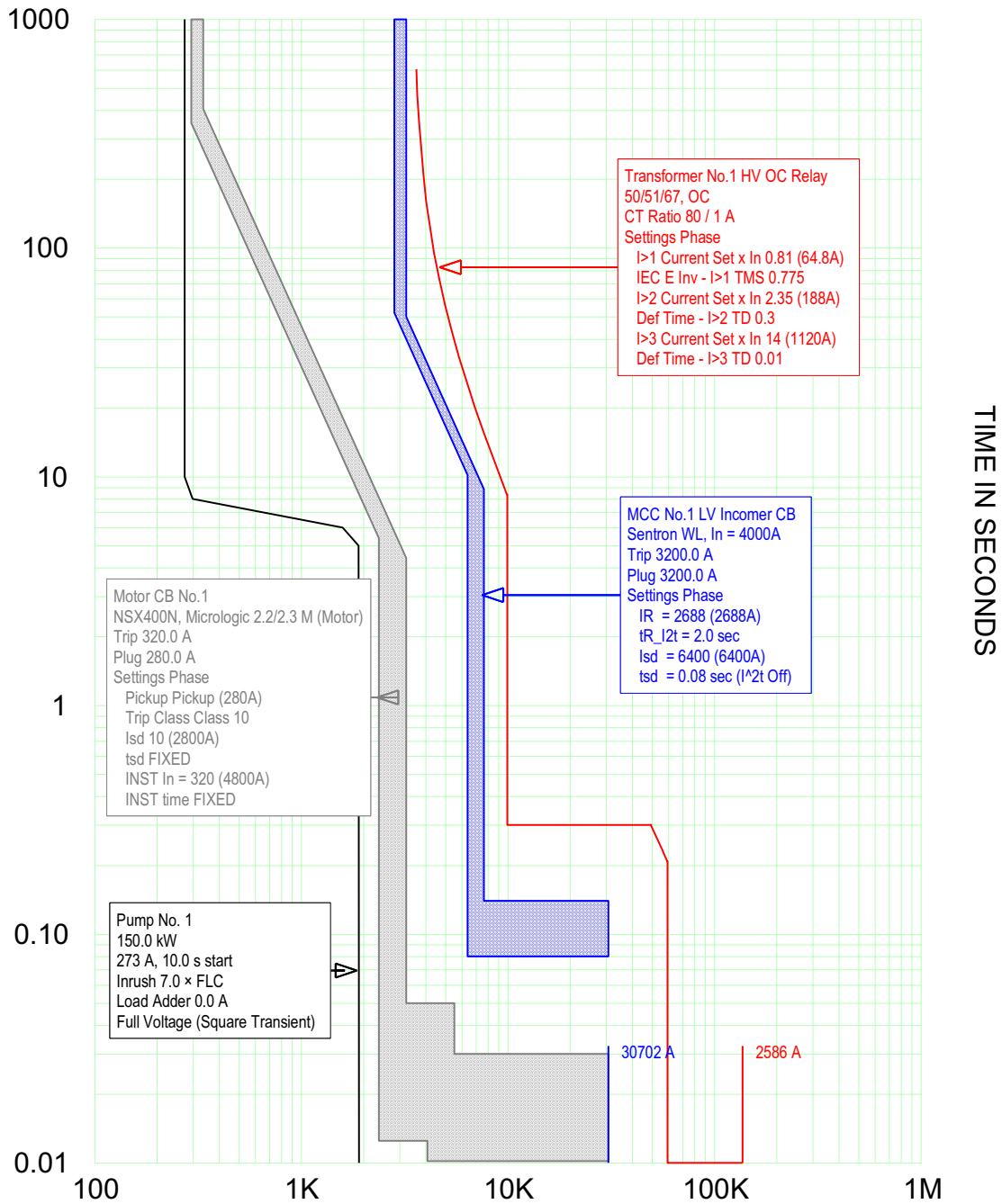

MCC.tcc Ref. Voltage: 415V  
Current in Amps x 1 @415 V x 0.019 @22 kV  
Bus Fault Current (IEC909 Ikpp 3P)

Example Figure 16: LV MCC Protection Settings. Revised to reduce incident energy.

### 13.1.3 High Voltage 22kV Switchboard

The process for assessing the 22kV switchboard is similar to the 415V switchboard.

However, the nominal voltage – 22,000 V – exceeds the range of the IEEE Std 1584 empirical model. Therefore the Lee Method must be used.

As with the 415 V MCC, eight calculations are required.

Example Table 11: 22kV Switchboard – Incident Energy Calculations

| Fault location                          | Switching Scenario | Arc Fault             | Busbar Arcing Fault Current (kA) | Incident Energy (cal/cm <sup>2</sup> ) |
|---|--------------------|-----------------------|----------------------------------|--|
| Busbar Fault<br>"Location 2"            | Maximum fault      | 100% I <sub>arc</sub> | <b>3.5 kA</b>                    | <b>19.0 cal/cm<sup>2</sup></b>         |
|   |                    | 85% I <sub>arc</sub>  | 3.0 kA                           | 16.3 cal/cm <sup>2</sup>               |
|   | Minimum fault      | 100% I <sub>arc</sub> | 2.6 kA                           | 14.1 cal/cm <sup>2</sup>               |
|   |                    | 85% I <sub>arc</sub>  | 2.2 kA                           | 12.0 cal/cm <sup>2</sup>               |
| Incomer line-side fault<br>"Location 1" | Maximum fault      | 100% I <sub>arc</sub> | <b>3.5 kA</b>                    | <b>33.5 cal/cm<sup>2</sup></b>         |
|   |                    | 85% I <sub>arc</sub>  | 3.0 kA                           | 28.7 cal/cm <sup>2</sup>               |
|   | Minimum fault      | 100% I <sub>arc</sub> | 2.6 kA                           | 24.9 cal/cm <sup>2</sup>               |
|   |                    | 85% I <sub>arc</sub>  | 2.2 kA                           | 22.9 cal/cm <sup>2</sup>               |

The calculation for Busbar Fault (Location 2) – Maximum Fault – 100% I<sub>arc</sub> is detailed below.

### 13.1.3.1 Example Calculation

#### Bolted Fault Current

From the PTW calculation results:

- Busbar bolted fault current: 3.5 kA
- Contribution from grid infeed: 3.4 kA
- Contribution from LV motors (back-feed through transformer): 0.1 kA

#### Bolted Fault Current → Arc Fault Incident Energy

The Lee Method calculations are simple compared to the IEEE Std 1584 empirical model:

- The arcing fault current is assumed equal to the bolted fault current.
- Only one formula is needed to calculate the incident energy.

The formula for the Lee Method is: (IEEE Std 1584 formula no. 7)

$$E = 2.142 \times 10^6 \times V \times I_{bf} \times \left(\frac{t}{D^2}\right)$$

|                 |                      |   |
|-----------------|----------------------|---|
| E               | [J/cm <sup>2</sup> ] | Arc fault incident energy                 |
| I <sub>bf</sub> | [kA]                 | The IEC 60909 bolted fault current        |
| V               | [kV]                 | 22 kV – nominal voltage of switchboard.   |
| t               | [sec]                | Arcing duration                           |
| D               | [mm]                 | 910mm – working distance for HV equipment |

- The bolted fault current is 3.5 kA

Due to the small size of the motor contribution in this example (< 3%), relative to the grid infeed, the motor contribution is not treated separately

- The arc fault duration is looked up against the time-current curve for the primary protection.

At 3.5kA, the 22kV switchboard incomer O/C relay trips on the I>>> definite time element, with 350 ms delay

Accounting for 50ms opening time for SF6 CB, the fault clearing time is 400 ms.

Given V = 22 kV, I<sub>bf</sub> = 3.5 kA, t = 0.4 sec, and D = 910mm,

$$E = 2.142 \times 10^6 \times V \times I_{bf} \times \left(\frac{t}{D^2}\right)$$

$$E = 2.142 \times 10^6 \times 22\text{kV} \times 3.5\text{kA} \times (0.4 \text{ sec}/910^2\text{mm})$$

$$E = 79.7 \text{ J/cm}^2 = 19.0 \text{ cal/cm}^2$$

**Arc Flash Boundary**

For the Lee Method, the arc flash boundary distance is defined by IEEE Std 1584 equation (9):

$$D_B = \sqrt{2.142 \times 10^6 \times V \times I_{bf} \left( \frac{t}{E_B} \right)}$$

|          |                      |   |
|----------|----------------------|---|
| $D_B$    | [mm]                 | The boundary distance   |
| $E_B$    | [J/cm <sup>2</sup> ] | Arc fault incident energy at the boundary – 5 J/cm <sup>2</sup> |
| $I_{bf}$ | [kA]                 | The IEC 60909 bolted fault current                              |
| $V$      | [kV]                 | 22 kV – nominal voltage of switchboard.                         |
| $t$      | [sec]                | Arcing duration   |

Using the same parameters  $I_{bf}$ ,  $V$ ,  $t$ , as above, the boundary distance is found to be 3.6 metres.

**13.1.3.2 Calculations for other cases**

The other results in Example Table 11 were calculated as follows.

- For the 85% arc fault current calculations, the bolted fault current  $I_{bf}$  was multiplied by 0.85
- The example calculation above was for maximum fault switching scenario, using the data from Example Figure 9

For minimum fault switching scenario, data from Example Figure 12, was used

- The example calculation above was for a busbar fault, at ‘Location 2’. These faults would be cleared by the 22kV incomer CB in 400 ms

For faults on the line side of the incomer, at ‘Location 1’, the faults are cleared by the backup protection – the 22kV point of connection relay

From Example Figure 14, the tripping time varies based on the fault current. An additional 50 ms is added for SF6 CB opening time



### 13.1.3.3 Determine required PPE level and generate warning label

From the results in Example Table 11 we conclude:

- Busbar faults: The worst case incident energy is 19.0 cal/cm<sup>2</sup>. This is in arc flash PPE Category 3 (8 – 25 cal/cm<sup>2</sup>)
- Line-side faults: The worst case incident energy is 33.5 cal/cm<sup>2</sup>. This is in arc flash PPE Category 4 (25 – 40 cal/cm<sup>2</sup>)

Based on this information, the warning label is generated, following DS29 Clauses 8, *Producing Arc Flash Warning Labels*, and Clause 7.4, *Operational Activities*, Table 7.

Note that this switchboard is arc-fault contained (see Example Figure 9). Therefore the PPE category with doors closed is Category 0, so long as the arcing fault current and duration is less than the arcing fault type test values.

- The switchboard arc fault rating is 12.5 kA, 1 seconds
- For busbar faults, the arc fault is 3.5 kA for 0.4 seconds
- For incomer faults, the arc fault is up to 3.5 kA for 0.71 seconds
- Both these values are less than the arc fault type test values, therefore Cat 0 applies when the switchboard doors are closed

**DATE: MAY 2016**

**JAMES COOK DR. PUMPING STN.  
EXAMPLE 22kV SWBD**

| ACTIVITY                                 | Minimum PPE Category |             |
|--|----------------------|-------------|
|  | Door Open            | Door Closed |
| <b>INCOMER</b>                           |                      |             |
| Racking                                  | CAT 4                | CAT 0       |
| Switching                                | CAT 4                | CAT 0       |
| <b>NON-INCOMER CIRCUITS</b>              |                      |             |
| Switching or Racking                     | CAT 3                | CAT 0       |
| Live Electrical Testing (power Circuits) | CAT 3                | N/A         |
| Operating Controls                       | CAT 3                | CAT 0       |
| Visual Inspection (Live Parts)           | CAT 3                | CAT 0       |

**ARC FLASH HAZARD**  
22 kV Shock Hazard

| <b>INCOMER ENERGY</b>               |                          |
|-------------------------------------|--------------------------|
| Incident energy @ 910 mm            | 33.5 cal/cm <sup>2</sup> |
| Arc Flash Boundary Whilst Switching | 4.8 m Clear Space        |

| <b>BUSBAR ENERGY</b>                |                          |
|-------------------------------------|--------------------------|
| Incident energy @ 910 mm            | 19.0 cal/cm <sup>2</sup> |
| Arc Flash Boundary Whilst Switching | 3.6 m Clear Space        |

Figure 17: Example warning label for 22kV Switchboard

### 13.1.4 Power\*Tools Software Example

The Power\*Tools for Windows software may be used to perform arc flash analysis without manual calculations.

#### 13.1.4.1 Study Options

The study setup options require careful attention. They should be as shown in the “options report” below. Options which are particularly important are highlighted in orange.

| ARC FLASH STUDY OPTIONS REPORT  |  |  |                         |      |
|---|--|--|-------------------------|------|
| <b>Standard</b>   | NFPA 70E 2015 Annex D.4 - IEEE 1584                    |  |                         |      |
| <b>Unit</b>   | Metric   |  |                         |      |
| <b>Flash Boundary Calculation Adjustments</b>   |  |  |                         |      |
| Use 1.2 cal/cm <sup>2</sup> (5.0 J/cm <sup>2</sup> ) for flash boundary calculation, no adjustment is made. |  |  |                         |      |
| <b>Equipment Below 240 V</b>  |  |  |                         |      |
| Report calculated incident energy values from equations   |  |  |                         |      |
| <b>Short Circuit Options</b>  |  |  |                         |      |
| <b>Include Transformer Tap</b>  | Yes  | <b>Pre-Fault Option</b>                      | PU for each bus         |      |
| <b>Include Transformer Phase Shift</b>  | No   | <b>Define Grounded as SLG/3P Fault</b><br>>= | 5 %                     |      |
| <b>Include Induction Motor Contribution</b>   | 5.0 cycles   | <b>Current Limiting Fuse</b>                 | All as current limiting |      |
| <b>Reduce Generator/Synch. Motor Contribution to</b>  | Do not represent generator and synchronous motor decay |  |                         |      |
| <b>Line Side Incident Energy Calculation</b>  | Include line side + load side fault contributions      |  |                         |      |
| <b>Recalculate Trip Time Using Reduced Current</b>  | No   | <b>Mis-Coordination Levels to search</b>     | 5                       |      |
| <b>Use Arc Flash Equations for Breakers and Fuses</b>   | Yes  | <b>Mis-Coordination Ratio</b>                | 80 %                    |      |
| <b>Report Options</b>   |  | <b>Arcing Fault Tolerance</b>                |                         |      |
| <b>Report Option</b>  | Bus + Line Side Report                                 | Low Voltage In Box                           | (-15%)                  | (0%) |
| <b>Label and Summary View</b>   | Report Last Trip Device                                | Low Voltage Open Air                         | (-15%)                  | (0%) |
| <b>Check Upstream Device for Mis-Coordination</b>   | Yes  | HV/MV In Box                                 | (-15%)                  | (0%) |
| <b>Cleared Fault Threshold</b>  | 80.0 %   | HV/MV Open Air                               | (-15%)                  | (0%) |
| <b>Max Arcing Duration</b>  | 2 seconds  |  |                         |      |
| <b>Increase PPE Level by 1 for high marginal IE</b>   | No   |  |                         |      |

The “Pre Fault Option” should be set to “Per Unit Voltage – Enter for Each Bus”. The voltages should then be set as per the pre-fault voltage factors of DS29 Clause 6.7, *Determine the Bolted Fault Current*, Tables 1 and 2.

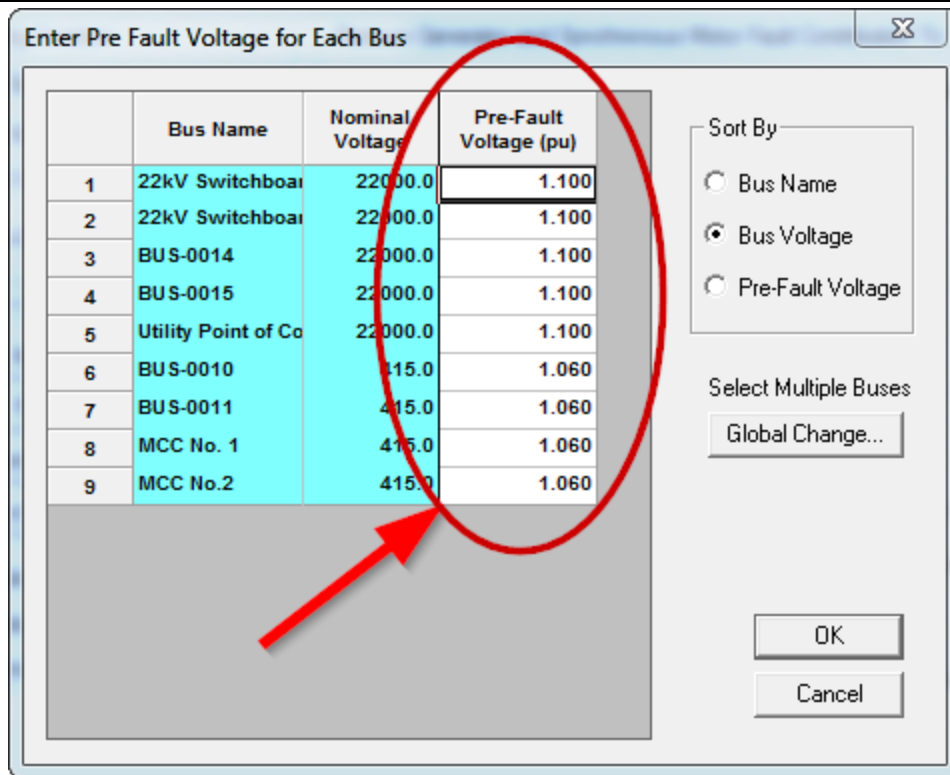

Example Figure 18: PTW study set-up - pre-fault voltages

### 13.1.4.2 Other pitfalls

Pay close attention to:

- Equipment type – most equipment should be SWG (Switchgear) or PNL (Panelboard), which represent enclosed equipment, i.e. “in a box” for IEEE Std 1584 calculation purposes

CBL (Cable box) and AIR (open-air) should not be used

- Working distances – the default for LV Switchgear is 610mm. This standard, DS 29, requires 455 mm
- Busbar gaps – PNL equipment type has busbar gap of 25mm vs. 32mm for SWG switchgear type
- Circuit breaker operating time – the PTW default is 60 ms, which is not appropriate for all circuit breakers

Note that the PTW Arc Flash module does not use the IEC 60909/AS 3851 method to calculate the bolted fault current. A different, proprietary method is used. Therefore the results will be slightly different to manual calculations using IEC 60909 bolted fault currents.

### 13.1.4.3 Results

The results for the 22kV switchboard, and the 415V MCC, are shown below.

- The results cover both busbar faults (‘Location 1’) and line-side incomer faults (‘Location 2’), which PTW marks with the words ‘Protection Device LineSide’
- These results are for the ‘maximum fault’ scenario. A full arc flash study would require a second set of results to be generated for the ‘minimum fault’ scenario. The two sets of results would then be merged externally, i.e. in an Excel spreadsheet

The PTW results are comparable to the manual calculations.

| Bus Name                     | 22kV Switchboard LH Section                        | 22kV Switchboard LH Section (22kV Switchboard Incomer OC LineSide) | MCC No.2               | MCC No.2 (MCC No.2 LV Incomer CB LineSide) |
|------------------------------|--|--|------------------------|--|
| Protective Device Name       | 22kV Switchboard Incomer OC                        | Point Of Conn. O/C Relay   | MCC No.2 LV Incomer CB | Transformer No.2 HV OC Relay               |
| Bus kV                       | 22   | 22   | 0.415                  | 0.415                                      |
| Bus Bolted Fault (kA)        | 3.24   | 3.24   | 34.32                  | 34.32                                      |
| Bus Arcing Fault (kA)        | 3.24   | 3.24   | 15.25                  | 15.25                                      |
| Prot. Dev. Bolted Fault (kA) | 3.16   | 3.16   | 30.83                  | 32.99                                      |
| Prot. Dev. Arcing Fault (kA) | 3.16   | 3.16   | 13.69                  | 14.66                                      |
| Trip/Delay Time (s)          | 0.341  | 0.654  | 0.260                  | 0.400                                      |
| Breaker Opening Time (s)     | 0.050  | 0.050  | 0.000                  | 0.050                                      |
| Ground                       | Yes  | Yes  | Yes                    | Yes  |
| Equip. Type                  | SWG  | SWG  | SWG                    | SWG  |
| Gap (mm)                     | 152  | 152  | 32                     | 32   |
| Arc Flash Boundary (mm)      | 3422   | 4583   | 2249                   | 3230                                       |
| Working Distance (mm)        | 910  | 910  | 455                    | 455  |
| Incident Energy (cal/cm2)    | 16.90  | 30.31  | 12.58                  | 21.44                                      |
| PPE Level                    | 3  | 4  | 3                      | 3  |
| Notes                        | (*N11): Out of IEEE 1584 Range, Lee Equation Used. | (*N11): Out of IEEE 1584 Range, Lee Equation Used.                 |                        |  |

## 13.2 Small installation

For smaller installation DS 29 provides for two methods of arc flash assessment:

- A simple, tabular lookup process
- The standard calculation approach using either manual ‘hand-calculations’ or Power\*Tools software.
- Stage 3 calculation

Consider the example equipment shown below:

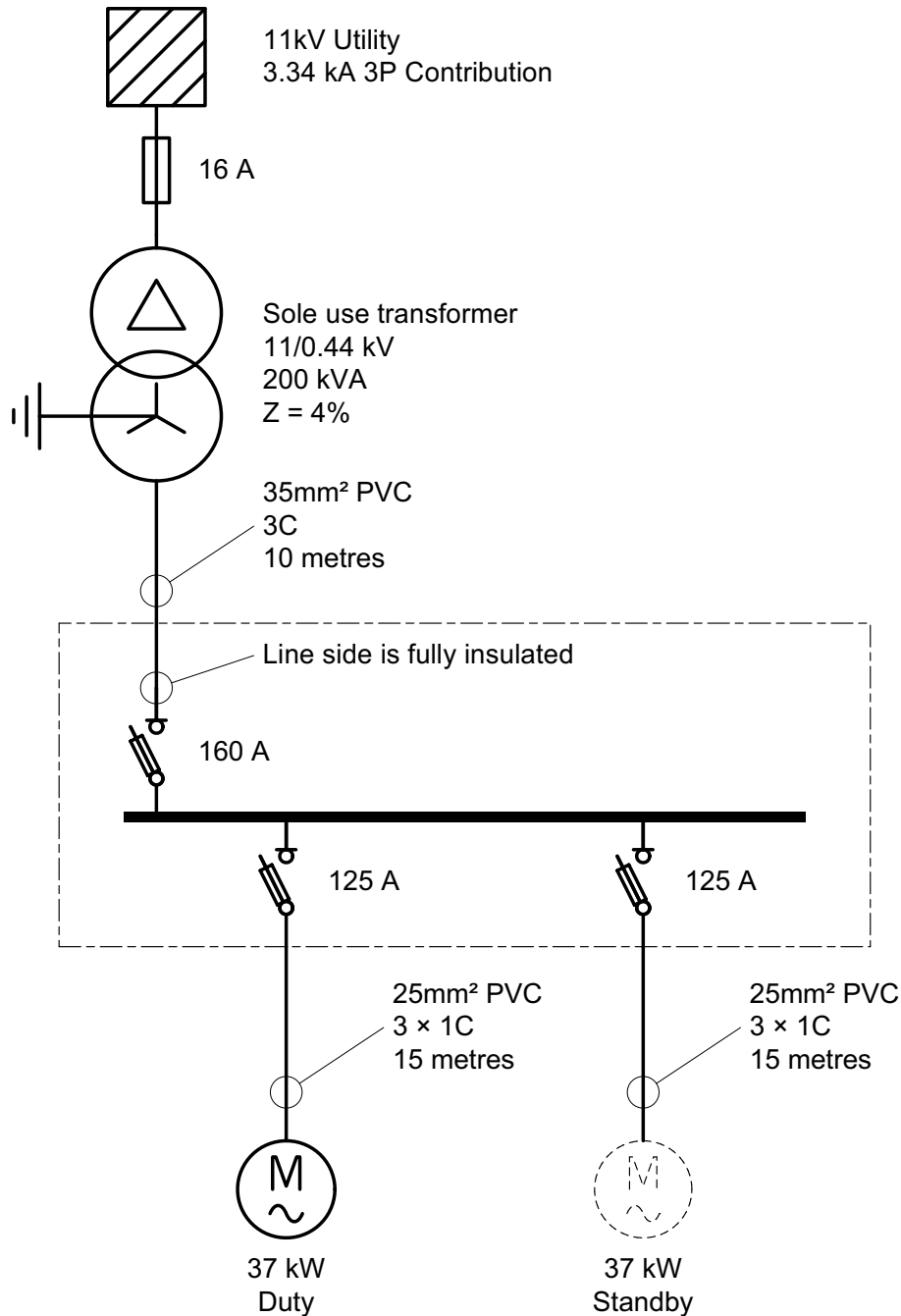

- Figure 19: Example of small pump station installation

### 13.2.1 Table-based approach

This LV switchboard is supplied by a transformer sized  $\leq 315$  kVA, and the line side of the incomer fuse is fully insulated. Therefore, we may apply the simple table-based method of DS 29 Section 9 – *When Arc Flash Calculations Are Not Required*.

The relevant details are:

- Supply type – sole-use transformer
- Transformer size – 200 kVA
- Incomer protection – 160 A fuse
- Incoming cable size – 70mm<sup>2</sup>
- Incoming cable length – 10 metres

Checking these details against DS29 Stage 1 Table 8a, *Criteria for Arc Incident Energy Levels at Sole Use and Street Main Transformers* yields a match with Stage 1 Table 8a of DS29.

**Extract of DS29 Table 8a**

| Transformer Type     | Switchboard supplied from | CAT 0 PPE              | CAT 1 PPE  |
|----------------------|---------------------------|------------------------|--|
| Sole Use Transformer | 200 kVA transformer       | No criteria identified | Fuse <sup>1</sup> $\leq 200$ A and<br>Incomer Cable $\geq 35$ mm <sup>2</sup> Cu and<br>Incomer Cable Length $\leq 10$ m |

All criteria are satisfied for “CAT 1 PPE”:

- Supply type – sole-use transformer ✓✓
- Transformer size – 200 kVA ✓✓
- Incomer protection – 160 A fuse  $\leq 200$  A ✓✓
- Incoming cable size – 35mm<sup>2</sup>  $\leq 70$ mm<sup>2</sup> ✓✓
- Incoming cable length – 10 metres  $\leq 10$  metres ✓✓

Therefore CAT 1 PPE applies to this switchboard.

The warning label is generated, following DS 29 Clauses 8, *Producing Arc Flash Warning Labels*, and Clause 7.4, *Operational Activities*, Table 7.

- The PPE requirement for ‘Incomer Switching’ and ‘Non-Incomer Switching’ are both based off the same results. This is because the line side of the incomer is fully insulated
- The PPE requirement for ‘Racking’ is ‘N/A’ because the incomer is a fuse-switch, which cannot be racked
- The PPE requirement for ‘Switching’ is CAT 1 for both the ‘doors open’ and ‘doors closed’ condition, as small pump station cubicles are not normally internal arc rated
- The PPE requirement for ‘Operating Controls’ and ‘Visual Inspection’ is CAT 0, as per Table 7
- The incident energy was not calculated, so use 4 cal/cm<sup>2</sup>, which is the upper limit for CAT 1
- The arc flash boundary was not calculated, and may be left blank

**DATE: JULY 2016**

**AVALON PUMP STATION  
EXAMPLE SMALL PUMP STN.**

**ARC FLASH HAZARD**  
415VAC Shock Hazard

| ACTIVITY                | Minimum PPE Category |             |   |
|-------------------------|----------------------|-------------|---|
|                         | Door Open            | Door Closed |   |
| INCOMER                 |                      |             | <b>INCOMER ENERGY</b>                               |
| Racking                 | N/A                  | N/A         | Incident energy @ 455 mm      4 cal/cm <sup>2</sup> |
| Switching               | CAT 1                | CAT 1       | Arc Flash Boundary Whilst Switching   -             |
| NON-INCOMER CIRCUITS    |                      |             | <b>BUSBAR ENERGY</b>                                |
| Switching or Racking    | CAT 1                | CAT 1       | Incident energy @ 455 mm      4 cal/cm <sup>2</sup> |
| Live Electrical Testing | CAT 1                | N/A         | Arc Flash Boundary Whilst Switching   -             |
| Operating Controls      | CAT 1                | CAT 0       |   |
| Visual Inspection       | CAT 1                | CAT 0       |   |

Figure 20: Example arc flash warning label for small pump station

## 13.2.2 Calculation-based approach

The use of the table-based method for small installations is a matter of convenience.

The full IEEE Std 1584 -based calculation method may also be applied to small installations. The full calculations will yield a more accurate (i.e. less conservative) result.

Less detail has been provided for this example than the previous Large Installation examples as the calculations follow the same approach.

As the line side is fully insulated a fault cannot occur at Location 1. Therefore only a busbar fault (Location 2) is required.

As before, the calculations must cover all combinations of:

- Minimum and maximum bolted-fault current
- 100% arcing current and 85% arcing current

Four calculations are required in total. The results of these calculations are shown in the table below.

| Fault location               | Switching Scenario | Arc Fault             | Busbar Arcing Fault Current (kA) | Incident Energy (cal/cm <sup>2</sup> ) |
|------------------------------|--------------------|-----------------------|----------------------------------|--|
| Busbar Fault<br>"Location 2" | Maximum fault      | 100% I <sub>arc</sub> | 4.55 kA                          | 0.19 cal/cm <sup>2</sup>               |
|                              |                    | 85% I <sub>arc</sub>  | 3.87 kA                          | 0.26 cal/cm <sup>2</sup>               |
|                              | Minimum fault      | 100% I <sub>arc</sub> | 3.79 kA                          | 0.2 cal/cm <sup>2</sup>                |
|                              |                    | 85% I <sub>arc</sub>  | <b>3.22 kA</b>                   | <b>0.3 cal/cm<sup>2</sup></b>          |

The calculation for Busbar Fault (Location 2) – Minimum Fault – 85% I<sub>arc</sub> is detailed below.

### Bolted fault current

From the PTW calculation results:

- Bus-bar bolted fault current: 5,230 A

There are two branch contributions:

- 4,790 A from supply transformer. (92% of total)
- 440 A from induction motors. (8% of total)

### Bolted Fault Current → Arcing Fault Current

The IEEE Std 1584 formula to convert the bolted fault to an arcing fault gives the arcing fault current as I<sub>a</sub> = 3.79 kA

### Arc fault duration

I<sub>a</sub> = 3.79 kA is the total busbar arc fault current.

For the reduced 85% case: I<sub>a</sub> = 3.79 kA x 0.85 = 3.22 kA

To determine the protection operating time, it is required to calculate how much of this current is seen by the protection device.

Recall that the branch fault contributions were – 92% from the system supply, and 8% from motor contribution.

Therefore, the 3.22 kA arcing current is broken into:

- System supply: 92% × 3.22 kA = 2.96 kA
- Motor contribution: 8% × 3.22 kA = 0.26 kA



The incomer 160A fuse will detect the 2.96 kA component. Based on the characteristic curve of the fuse the clearing time is 40 milliseconds.

The clearing time for the 0.26 kA motor contribution is 100 milliseconds.

### **Arc fault incident energy**

The IEEE 1584 formulas are used to calculate the incident energy value.

As these two sources of fault current clear at different times two calculations are required. The first calculation is as follows:

- *System supply and motor contribution*  
 $I_a = 2.96 \text{ kA} + 0.26 \text{ kA} = 2.96 \text{ kA}$   
 $t = 40 \text{ ms}$   
 $\rightarrow E = 0.27 \text{ cal/cm}^2$
- *System supply cleared, only motor contribution remaining*  
 $I_a = 0.26 \text{ kA}$   
 $T = 100\text{ms} - 40 \text{ ms} = 60 \text{ ms}$   
 $\rightarrow E = 0.03 \text{ cal/cm}^2$ .

The total incident energy is the sum of the two calculation results

$$E = 0.27 \text{ cal/cm}^2 + 0.03 \text{ cal/cm}^2 = \underline{\underline{0.3 \text{ cal/cm}^2}}$$

### **Arc flash boundary**

The IEEE 1584 formulas are used to calculate the arc flash boundary = 230 mm

### **Arc flash warning label**

The arc flash warning is very similar to the label presented in Figure 12, except Cat 1 would be replaced with Cat 0 and the actual incident energy levels and arc flash boundary would be included.

### **Discussion**

The calculated arc flash incident energy is 0.3 cal/cm<sup>2</sup>, which is in the Category 0 range. This is a lower result than the table-lookup method, which gives a result of Category 1.

This illustrates that the table-lookup method is conservative.

## **13.3 Constant Clearing Time Curves**

Switchboard fed from a 315 kVA transformer

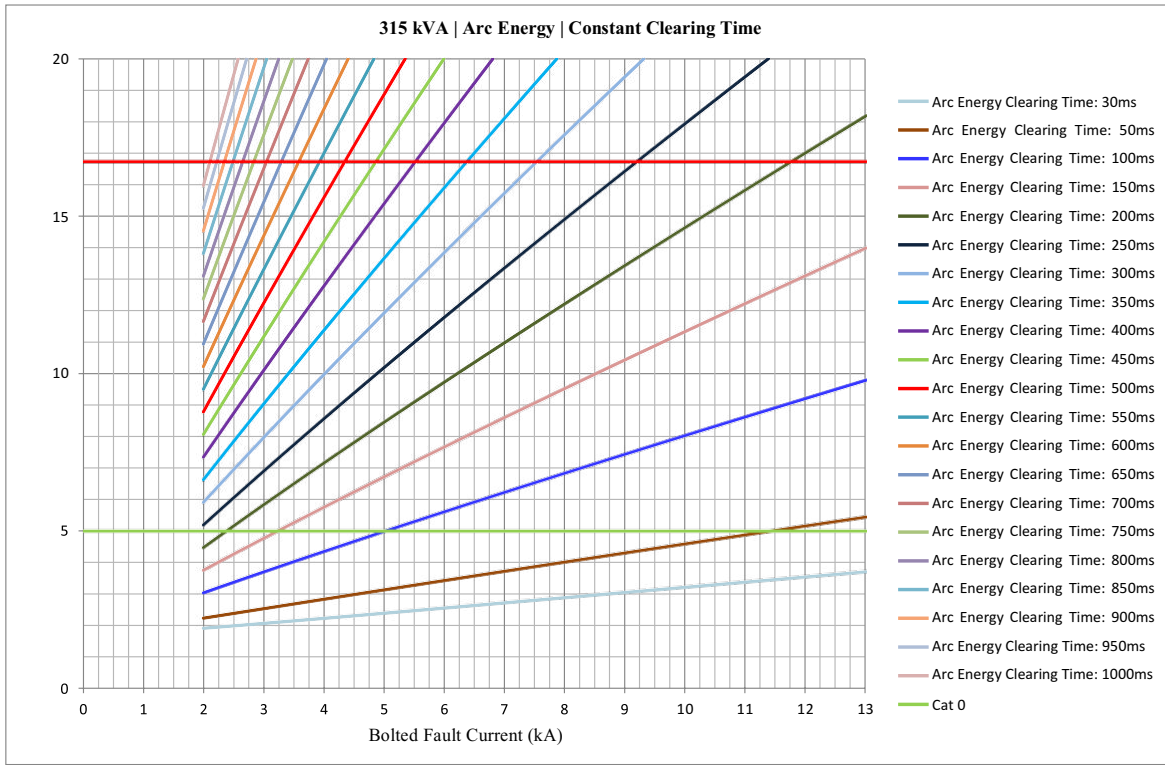

Switchboard fed from a 200 kVA transformer

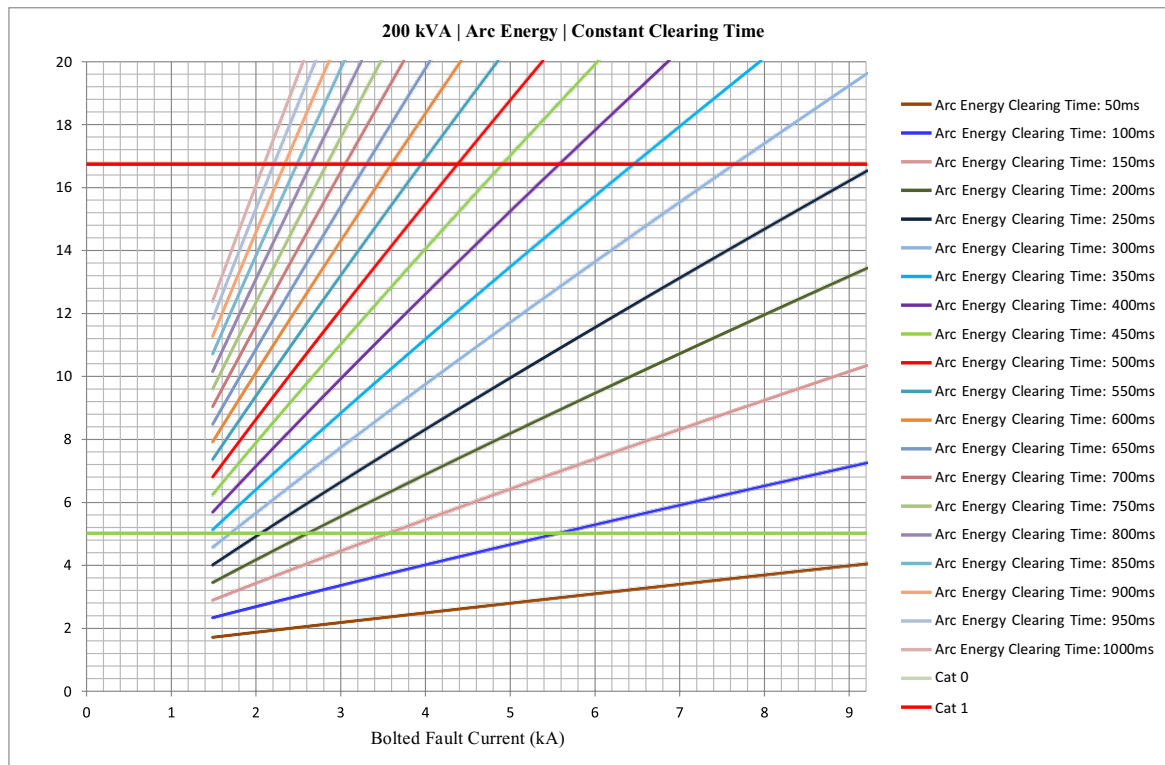

Switchboard fed from a 160 kVA transformer

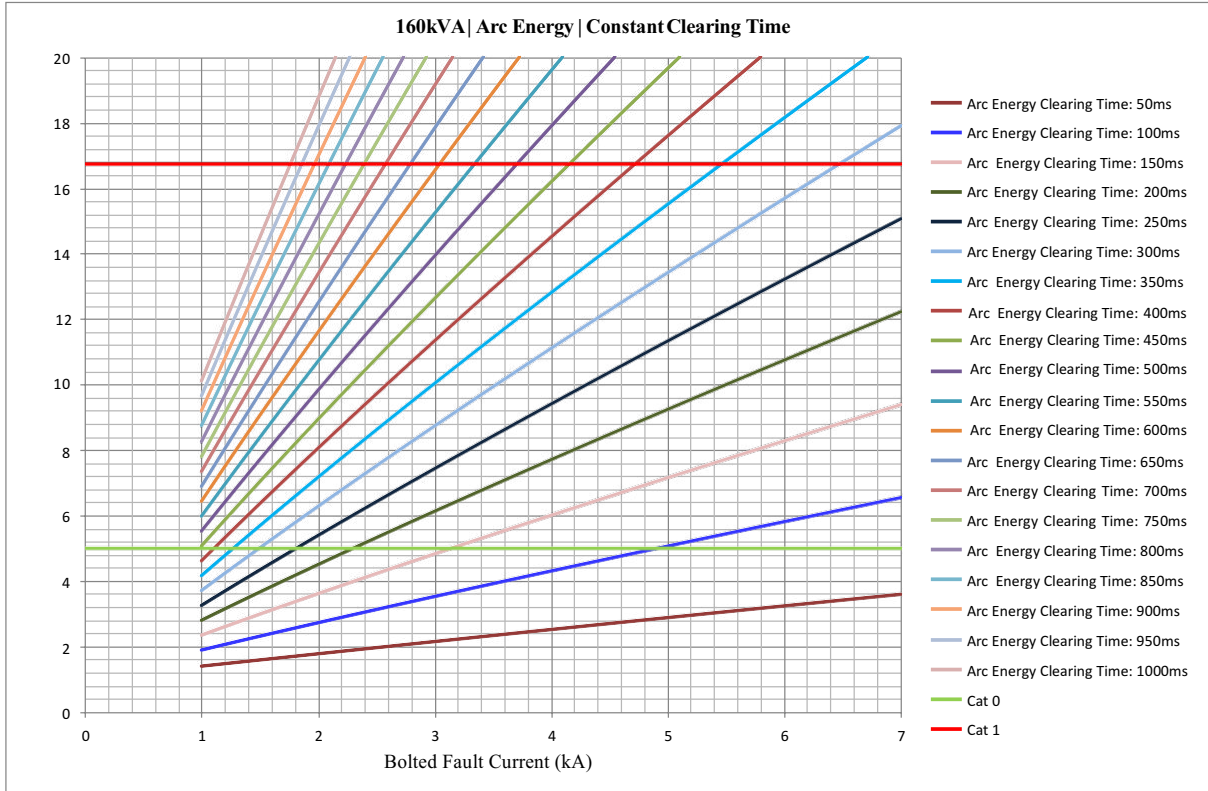

Switchboard fed from a 100 kVA transformer

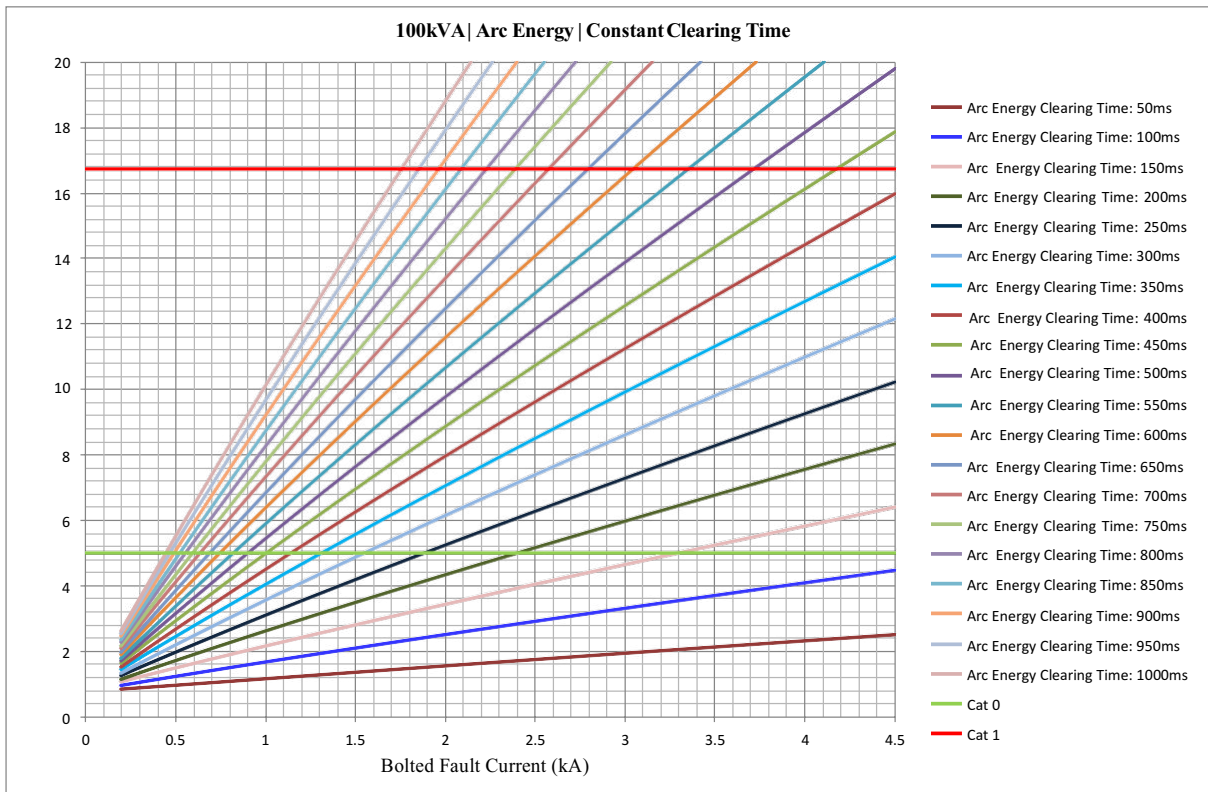

Switchboard fed from a 63 kVA transformer

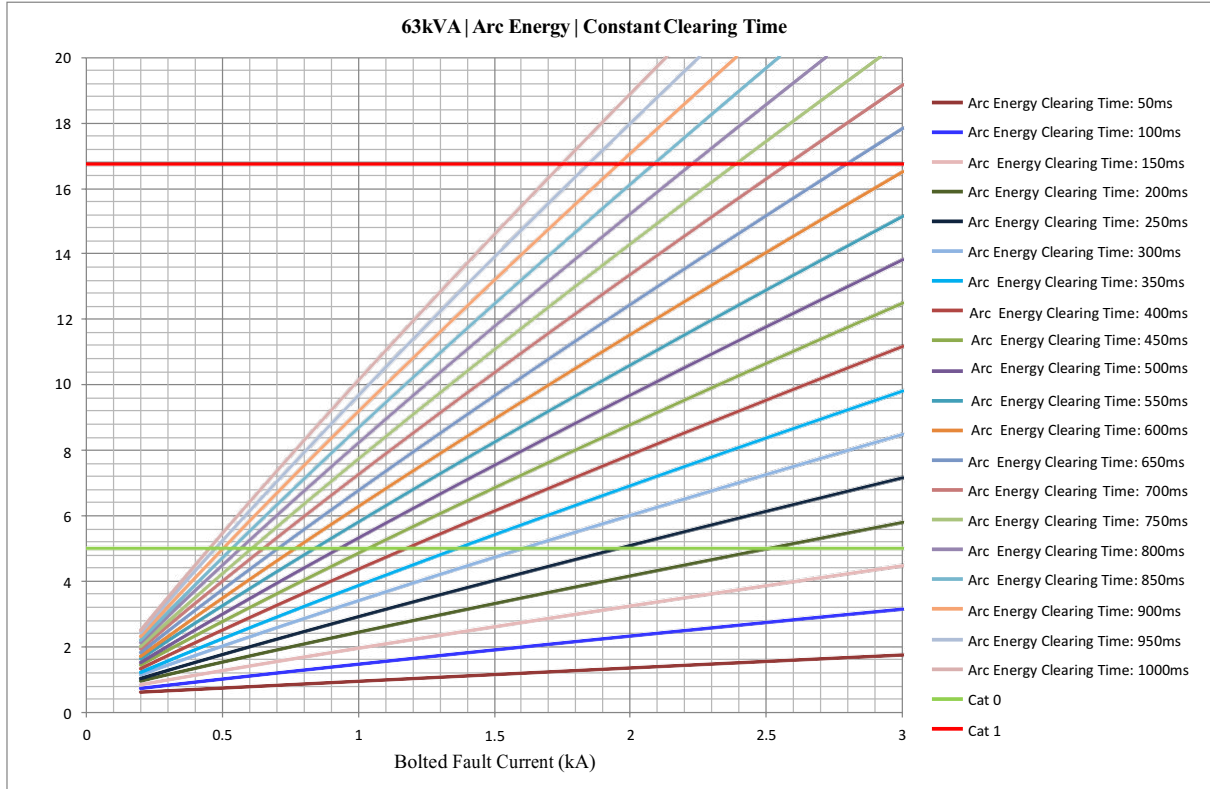

## 13.4 Maximum Corresponding Arc Fault Currents

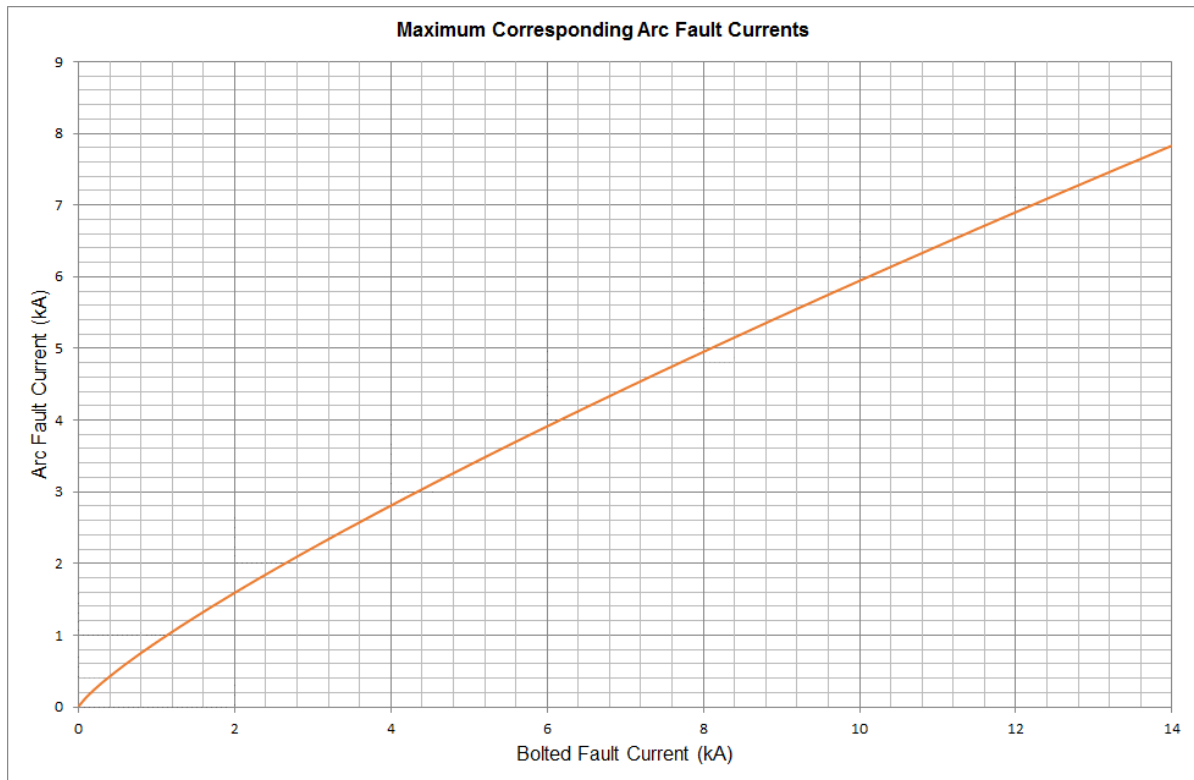

## 13.5 Example for Stage 3 Assessment

Example: Switchboard supplied from a 200 kVA transformer:

- Step 1: Calculate value of minimum and maximum bolted three-phase short-circuit currents at the switchboard using IEC 60909 method:
  - Minimum three-phase short-circuit current: 4.5 kA
  - Maximum three-phase short-circuit current: 5.5 kA
- Step 2: The minimum arcing current corresponding to minimum bolted three-phase current of 4.5 kA is 3.1 kA (refer curve in Appendix 13.4, also shown below)

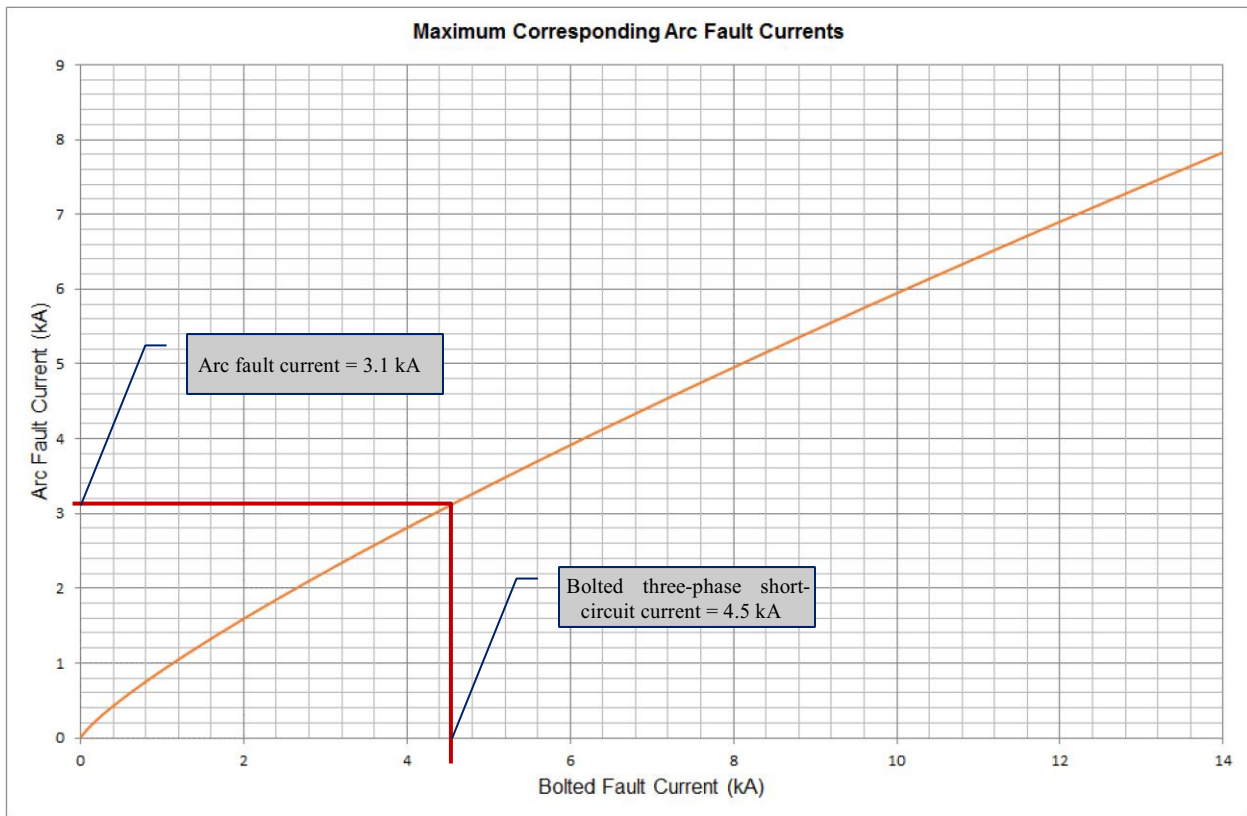

- Step 3: The short-time (definite-time curve with  $I^2t = \text{OFF}$ ) for the circuit breaker protection pickup is 2.5 kA (determined from protection-coordination study) is less than the minimum arcing fault current of 3.1 kA, therefore, the circuit breaker will pick up the minimum arcing current
- Step 4: The total arc energy clearing time i.e. short-time protection element operating time and circuit breaker opening time is 120 ms (determined from protection-coordination study)
- Step 5: The switchboard is supplied from a 200 kVA transformer, therefore, select the applicable curve 'Constant Clearing Time' is from Appendix A13.3
- Step 6: The curve 'Constant Clearing Time' does not have a curve for 120 ms arc energy clearing time. Therefore, a conservative approach by using 150 ms arc energy clearing time is recommended. The arc incident energy from the selected curve 'Constant Clearing Time' corresponding to 'arc energy clearing time = 150ms and maximum three-phase bolted fault current (5.5 kA) is 7 J/cm<sup>2</sup> which is below CAT 1 and more than CAT 0 level. Therefore, an arc fault category of CAT 1 is selected for the switchboard

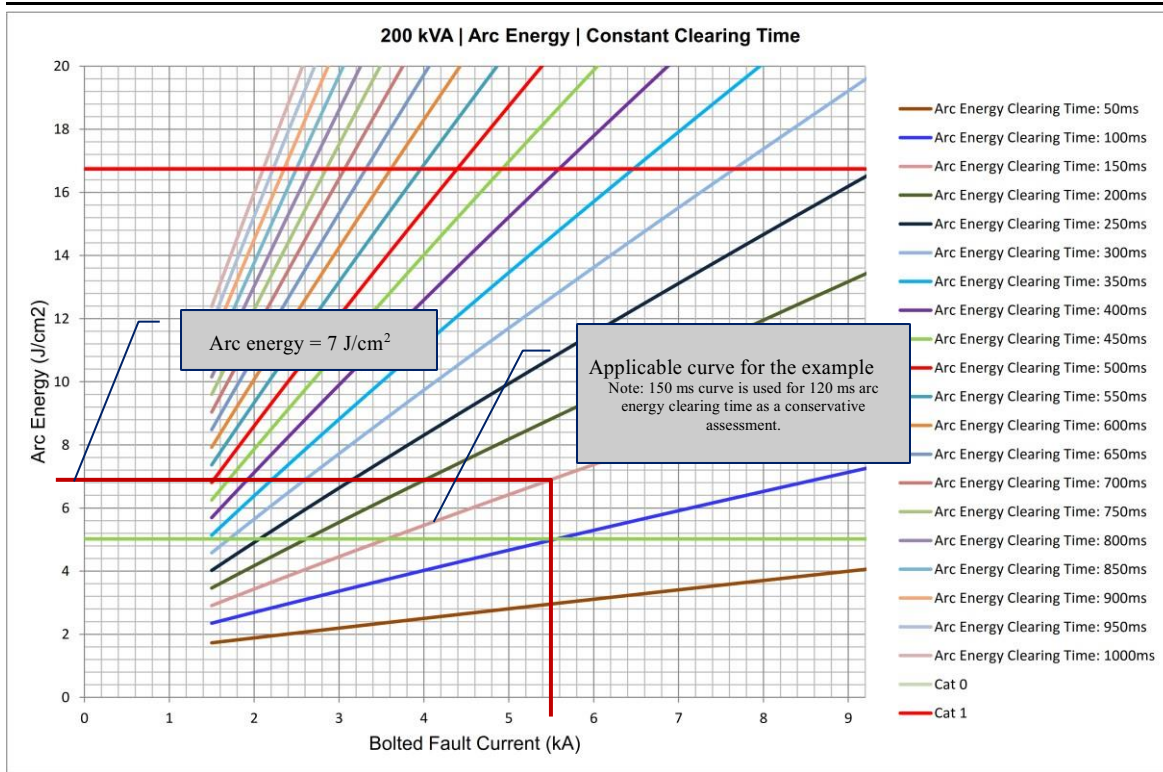

## 13.6 Lineside and Busbar Energy Reduction Process

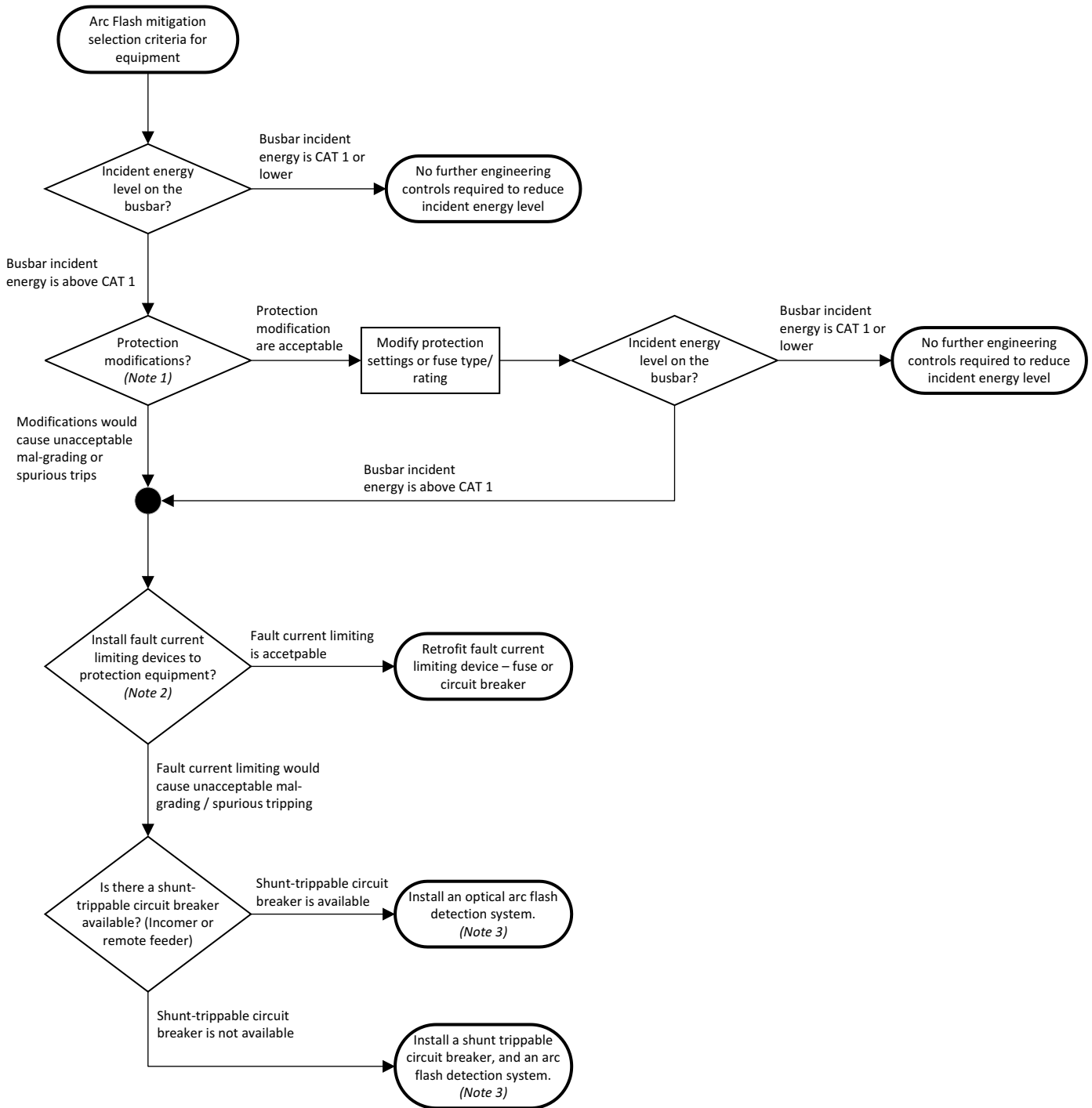

Figure 21: Busbar Incident Energy Reduction selection Flowchart



**Note 1** – ‘Unacceptable malgrading’ is defined as any protection modification which impairs protection grading between a switchboard’s main protection and its outgoing feeder circuit protection.

**Note 2** – Installing an arc fault current limiting device as the main protection will always impair protection grading between the fault current limiting device and any outgoing feeder circuit protection that is present. Therefore, arc fault current limiting devices can only be installed where either there are no outgoing feeder circuits (soft starters, VVVF drives, DOL motor starters) or protection grading is less critical (some non- essential light and small power distribution boards). Generally, for switchboards requiring incident energy reduction, the recommended method is to install an arc flash detection system.

**Note 3** – Where the circuit breaker is the local switchboard incomer, insulate and / or phase-barrier any uninsulated conductors and terminals line side of the circuit breaker.

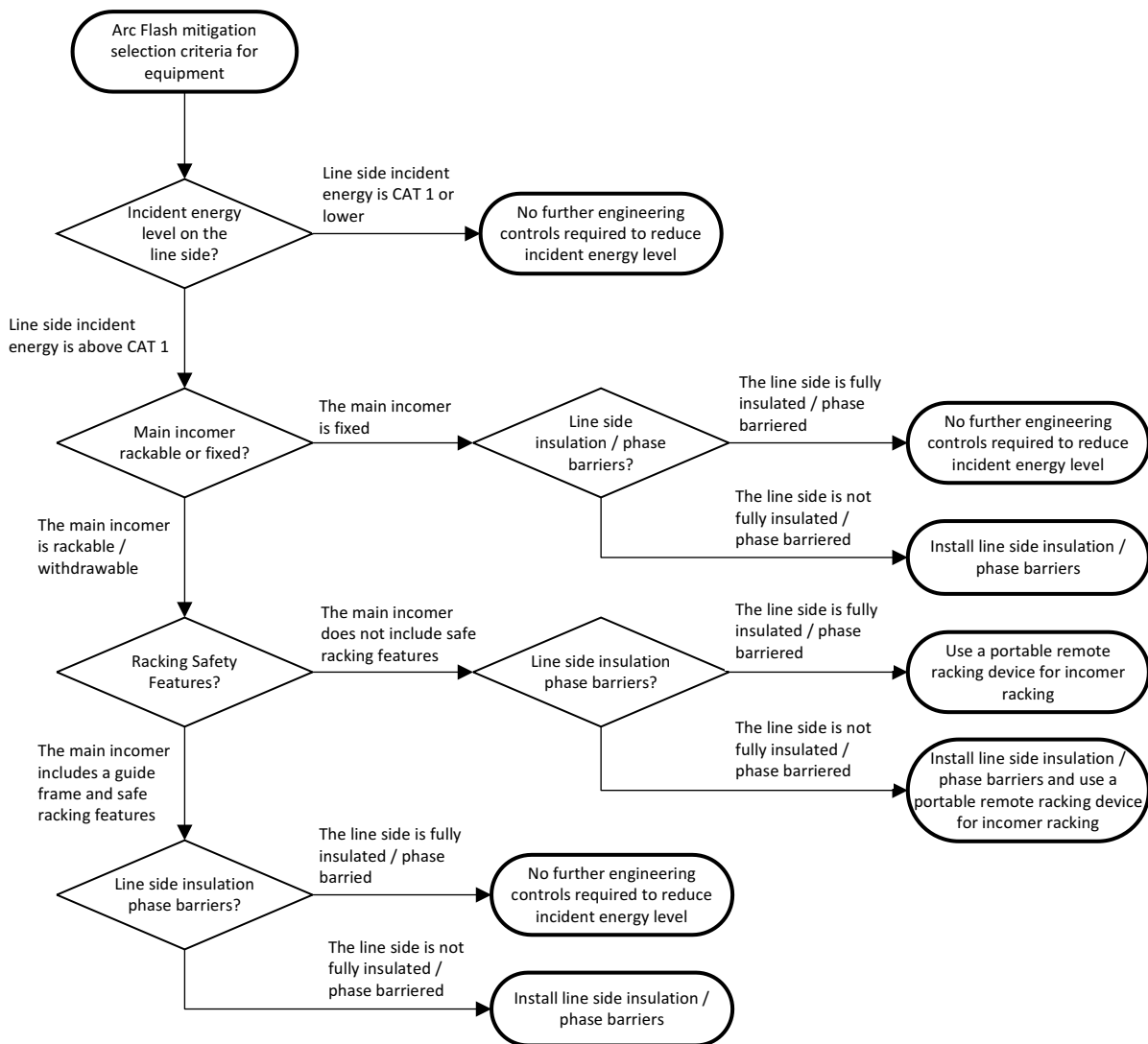

Figure 22: Lineside Incident Energy Reduction Selection Flowchart

# 14 Appendix B – Arc Flash Hazard Rated Category of Temporary Generators

The arc flash hazard rated category for temporary generators is presented in the Table 11 below.

Table 11: Hazard Rated Category levels for each group of the generator sizes

| Maximum Generator size (kVA) | CAT0  | CAT1  | CAT2   | CAT 3                            |
|------------------------------|---|---|--|----------------------------------|
| 50                           | Protection short-time pickup current <210A and protection trip time <1400ms | Highest Expected Hazard Category  | N/A  | N/A                              |
| 100                          | Protection short-time pickup current <380A and protection trip time <600ms  | Highest Expected Hazard Category  | N/A  | N/A                              |
| 200                          | Requires Detailed Assessment  | Protection short-time pickup current <660A and protection trip time <1100ms | Highest Expected Hazard Category   | N/A                              |
| 300                          | Requires Detailed Assessment  | Protection short-time pickup current <920A and protection trip time <750ms  | Highest Expected Hazard Category   | N/A                              |
| 400                          | Requires Detailed Assessment  | Protection short-time pickup current <1170A and protection trip time <650ms | Protection short-time pickup current <1170A and protection trip time <1500ms | Highest Expected Hazard Category |
| 500                          | Requires Detailed Assessment  | Protection short-time pickup current <1400A and protection trip time <120ms | Protection short-time pickup current <1400A and protection trip time <900ms  | Highest Expected Hazard Category |
| 600                          | Requires Detailed Assessment  | Protection short-time pickup current <1630A and protection trip time <90ms  | Protection short-time pickup current <1630A and protection trip time <700ms  | Highest Expected Hazard Category |
| 700                          | Requires Detailed Assessment  | Protection short-time pickup current <1850A and protection trip time <30ms  | Protection short-time pickup current <1850A and protection trip time <450ms  | Highest Expected Hazard Category |
| 800                          | Requires Detailed Assessment  | Requires Detailed Assessment  | Protection short-time pickup current <2060A and protection trip time <300ms  | Highest Expected Hazard Category |
| 900                          | Requires Detailed Assessment  | Requires Detailed Assessment  | Protection short-time pickup current <2270A and protection trip time <150ms  | Highest Expected Hazard Category |

| Maximum Generator size (kVA) | CAT0                         | CAT1                         | CAT2  | CAT 3                            |
|------------------------------|------------------------------|------------------------------|---|----------------------------------|
| 1000                         | Requires Detailed Assessment | Requires Detailed Assessment | Protection short-time pickup current <2470A and protection trip time <120ms | Highest Expected Hazard Category |

## **15 Appendix C – DC Arc Flash Assessment**

### **15.1 DC Arc Flash Assessment Overview**

DC Arc Flash Assessment shall be undertaken during Engineering Design for Water Corporation DC equipment rated above 60V. Arc flash assessments are not required for DC voltages below 60V.

IEEE 1584 and NFPA70E do not address arc flash hazard assessments in DC systems. Instead, DC Arc Flash calculations shall be undertaken using the Ammerman method of calculation. The Ammerman method of calculation originated as an IEEE paper which was developed from the principles and theory of arcs, drawing on past research to develop a model of DC arc resistance.

The Ammerman method is preferred rather than another commonly used approach, the Doan Method, which also originated as an IEEE paper and has been adopted by the Australian Standard AS/NZS 5139:2019. The Doan method, although simpler to calculate, provides a less accurate and more conservative estimate of arc flash incident energy levels.

### **15.2 Outcomes of a DC Arc Flash Assessment**

The outcomes of a DC arc flash assessment are the same as for an AC assessment and include the following:

- Incident Energy at the working distance
- Arc flash boundary (the closest approach distance where the incident energy level is 1.2 cal/cm<sup>2</sup>)
- Hazard rating category (refer to Table 6)

### **15.3 Assessment Scenarios**

DC arc flash assessments shall be undertaken for DC switchboards (enclosures with circuit breakers or isolating switches are defined as switchboards) and at locations external to switchboards where workers could potentially come into contact with live DC terminals.

On DC switchboards the possible locations where an arc flash could occur are the same as for AC switchboards. DC switchboard arc flash assessments shall be undertaken at Location 1 and 2.

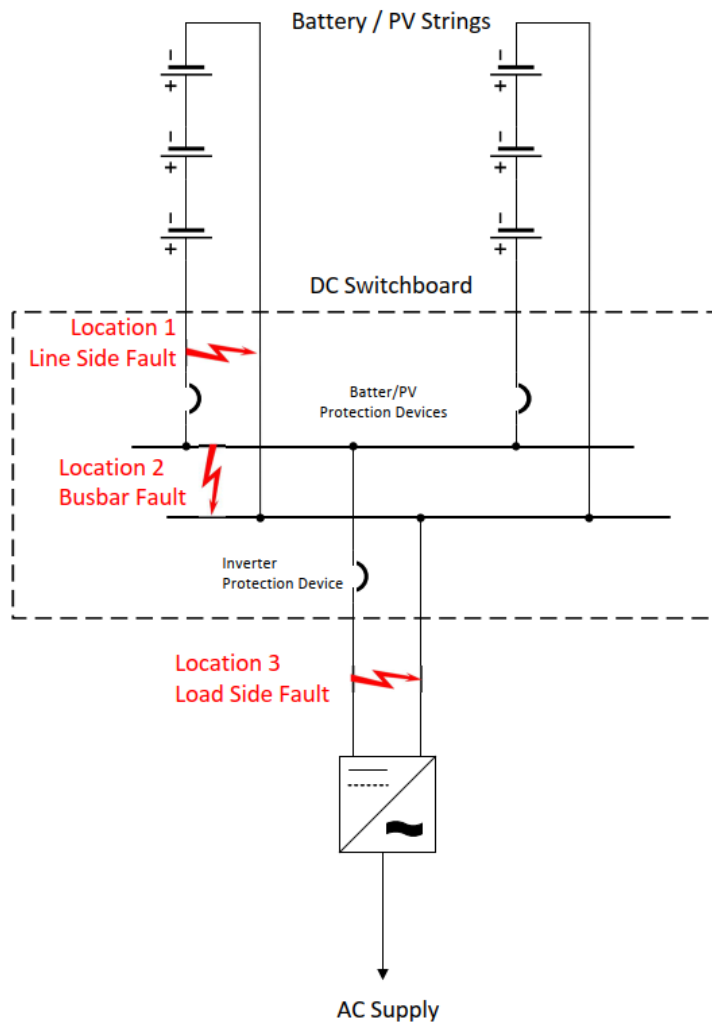

Figure 23 – DC Arc Flash Locations

External to switchboards, DC arc flash assessments shall be undertaken at the worst-case arc flash location. This location would most often be at the end of a string of batteries before the string protection device, where the fault would not be cleared by protection.

## 15.4 DC Arc Flash Assessment Overview – Steps

The following steps shall be undertaken, in the order listed, to assess DC arc flash incident energy levels and arc flash boundaries:

- Collect the system and equipment data
- Determine the bolted fault current and DC source resistance
- Determine the arc gap
- Calculate the arc fault resistance and arc fault current
- Assess the duration of the arcing fault
- Determine the working distance
- Determine the incident energy and hazard rating category at the working distance
- Determine the arc flash boundary (closest safe approach distance)

*Note:* The PTW DC Arc Flash module does not use the Ammerman method (it uses the Doan method) to assess incident energy and therefore cannot be used. For DC arc flash assessment, a spreadsheet is the recommended method of calculating incident energy. To assist calculations the *DS29 Addendum - DC Arc Flash - Calculation Module – Ammerman Method* spreadsheet has been developed and is available on the Water Corporation website for Designers. For simplicity the DC Arc Flash steps are shown below.

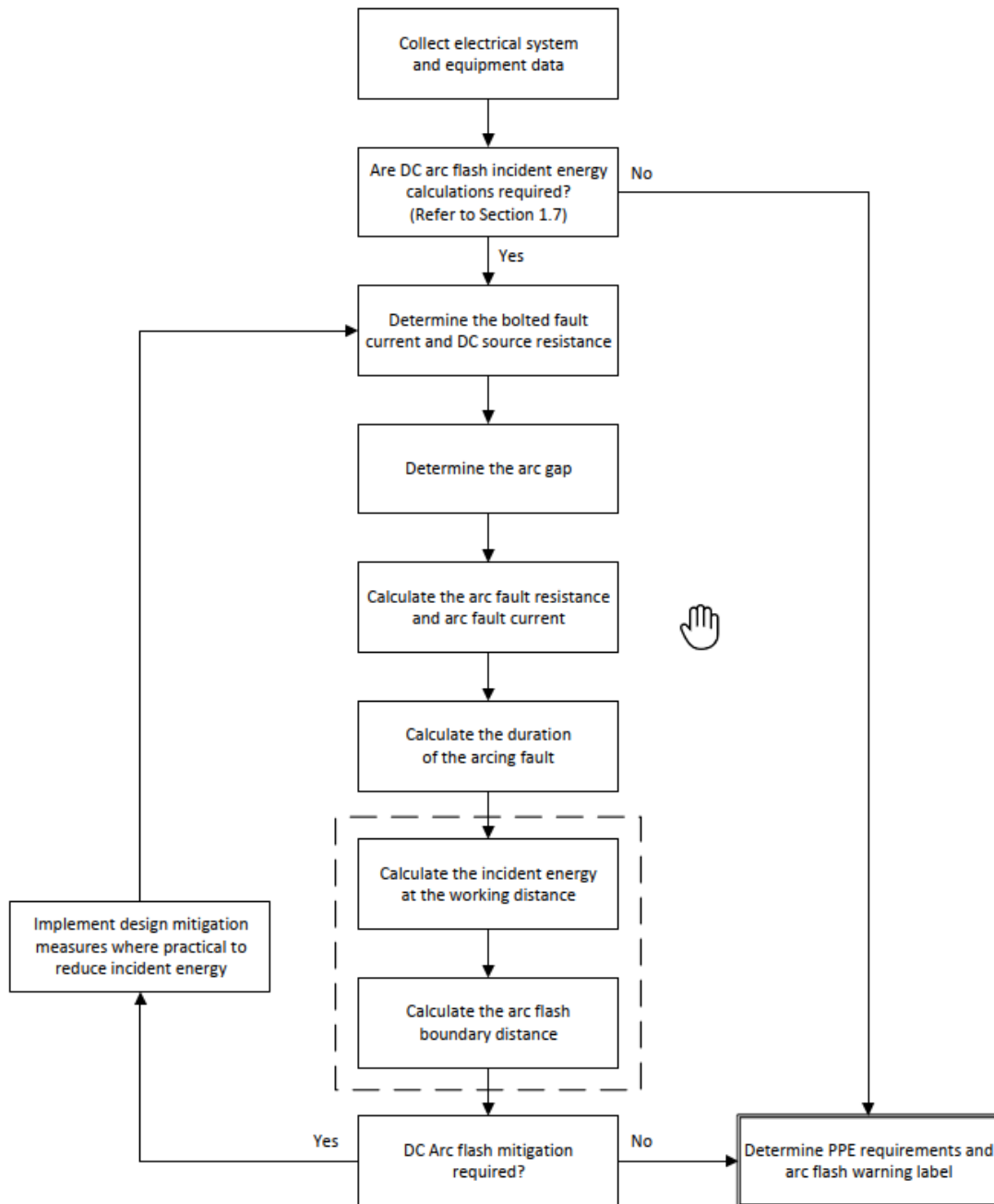

Figure 24 – High level process flowchart

### 15.4.1 Collect the system and equipment data

The following system and equipment data need to be collected:

The nominal voltage of the DC source.

The number of batteries or PV panels per string and the number of strings.

The fault current produced by DC sources. The fault current can also be estimated from the internal resistance of the DC source using Ohm's Law. The fault current or internal resistance data can be obtained by consulting equipment manufacturers if this information is not readily available from the product literature.

The time current characteristics / settings of all the protection devices that would trip to clear an arcing fault.

Whether the fault location is in an enclosure or in open air.

### 15.4.2 Determine the bolted fault current and DC source resistance

Ohm's law can be used to calculate the bolted fault current from the DC source resistance or to calculate the DC source resistance from the bolted fault current:

$$R_{source} = \frac{V_{DC}}{I_b} \quad \text{or} \quad R_{source} = \frac{V_{DC}}{I_b}$$

Where:

- Resource is the resistance of the DC source, comprised of the source internal resistance and cable resistance between the source and the location of the fault ( $\Omega$ )
- VDC is the nominal voltage of the DC source (V)
- $I_b$  is the bolted fault current at the location of the fault (A)

Where multiple contributing branches exist, the total bolted fault current at the fault location is determined by the addition of the separate branch contributions. An equivalent source resistance can be calculated for multiple contributing branches using the total bolted fault current value.

### 15.4.3 Determine the arc gap

In general, an arc gap of 25mm shall be used, unless the actual arc gap is available from the product literature, site data collection or other source of information.

### 15.4.4 Calculate the arc fault resistance and arc fault current

The following steps shall be undertaken to calculate the arc fault resistance and arc fault current:

Assume a value of arc fault current which is half the value of the bolted fault current

Calculate an initial arc resistance:

$$R_{arc} = \frac{20 + (0.534 \times Arc\ Gap)}{I_{arc}^{0.88}}$$

Where:

- $I_{arc}$  is the arc fault current (A)
- Arc Gap is the length of the air gap at the arc fault location (mm)
- $R_{arc}$  is the arc resistance ( $\Omega$ )

Re-calculate arc fault current using the previously calculated arc resistance:

$$I_{arc} = \frac{V_{DC}}{R_{source} + R_{arc}}$$

- a. Re-calculate the arc resistance using the arc fault current calculated in step c and the formula in step b
- b. Continue repeating steps c and d, until the arc resistance and arcing current values no longer change significantly (less than 5%) and converge to a final answer

Where multiple contributing branches exist, the arc fault current contributions from each branch are determined by assessing the total arcing fault current at the arc location, and then dividing this total arcing current among the contributing branches in the same proportion as the bolted fault current branch contributions.

### 15.4.5 Assess the duration of the arcing fault

The duration of the arcing fault is determined by assessing the clearance times of the protection devices under arcing fault conditions. The principles of assessing the duration of the arcing fault are the same as for an AC arc fault – refer to Section 6.10.

Where protection devices do not exist or the arc duration is longer than 2s, a maximum clearance time of 2s shall be used in the calculations.

### 15.4.6 Determine the working distance

The working distance for DC equipment shall be the same as LV AC Switchboards – 455mm.

### 15.4.7 Determine the incident energy at the working distance

For DC arcs **in open air** the incident energy is calculated as follows:

$$Incident\ energy\ @\ 455mm = \frac{I_{arc}^2 \times R_{arc} \times t_{arc} \times 1.902}{455^2}$$

For DC arcs in an enclosure (**panel/enclosure or switchboard**) the incident energy is calculated as follows:

$$Incident\ energy\ @\ 455mm = \frac{I_{arc}^2 \times R_{arc} \times t_{arc} \times k \times 23.9}{455^2 + a^2}$$

Where:

- Incident energy is the amount of energy at the working distance (cal/cm<sup>2</sup>)
- $t_{arc}$  is the duration of the arcing fault (s)
- **k** and **a** are constants as defined in the table below

|                        |          |          |
|------------------------|----------|----------|
| <b>Enclosure Type*</b> | <b>a</b> | <b>k</b> |
|------------------------|----------|----------|



|                    |     |       |
|--------------------|-----|-------|
| DC panel/enclosure | 100 | 0.127 |
| DC switchboard     | 400 | 0.312 |

\*A DC enclosure/panel without a DC circuit breaker or isolating switch is defined as a ‘DC panel/enclosure’. A DC enclosure/panel with a DC circuit breaker is defined as a ‘DC switchboard’.

### 15.4.8 Determine the arc flash boundary

For DC arcs **in open air** the arc flash boundary is calculated as follows.

Single branch contribution:

$$AFB = \sqrt{\frac{I_{arc}^2 \times R_{arc} \times t_{arc}}{0.631}}$$

Multiple branch contributions:

$$AFB = \sqrt{\frac{\{[(I_1 + I_2 + \dots + I_N)^2 \times t_1] + [(I_2 + \dots + I_N)^2 \times (t_2 - t_1)] + \dots + [I_N^2 \times (t_N - t_{N-1})]\} \times R_{arc}}{0.631}}$$

For DC arcs in a **panel/enclosure** the arc flash boundary is calculated as follows.

Single branch contribution:

$$AFB = \sqrt{I_{arc}^2 \times R_{arc} \times t_{arc} \times 2.377}$$

Multiple branch contributions:

$$AFB = \sqrt{\{[(I_1 + I_2 + \dots + I_N)^2 \times t_1] + [(I_2 + \dots + I_N)^2 \times (t_2 - t_1)] + \dots + [I_N^2 \times (t_N - t_{N-1})]\} \times R_{arc} \times 2.377}$$

For DC arcs in a **switchboard** the arc flash boundary is calculated as follows.

Single branch contribution:

$$AFB = \sqrt{I_{arc}^2 \times R_{arc} \times t_{arc} \times 3.487}$$

Multiple branch contributions:

$$AFB = \sqrt{\{[(I_1 + I_2 + \dots + I_N)^2 \times t_1] + [(I_2 + \dots + I_N)^2 \times (t_2 - t_1)] + \dots + [I_N^2 \times (t_N - t_{N-1})]\} \times R_{arc} \times 3.487}$$

Where:

- AFB (arc flash boundary) is the distance from the arc source at which the incident energy is equal to 1.2 cal/cm<sup>2</sup> (mm)
- I<sub>1</sub> is the arc fault current contribution from the first contributing branch to trip (A)
- I<sub>N</sub> is the arc fault current contribution from the N<sup>th</sup> branch – the last contributing branch to trip (A)
- t<sub>1</sub> is the trip time of the first contributing branch to trip (A)
- t<sub>N</sub> is the trip time of the Nth (last) contributing branch to trip (A)

## 15.5 15.5 Selecting PPE

The minimum required PPE categories for a DC arc flash occurring on a switchboard shall be determined in the same way that PPE is selected for an AC switchboard – refer to Section 7.

For DC arc flash hazards on non-switchboard locations, such as on terminals of batteries installed on a shelf or other exposed areas, PPE will be selected based on the calculated hazard rating category at the working distance – refer to Table 6.

## 15.6 Arc Flash Warning Labels

For DC switchboards the labels shall be produced in the same format as labels for AC Switchboards – refer to Section 8.

For DC arc flash hazards on non-switchboard equipment a simplified label shall be produced with the table of activities and door open / door closed summary removed, and only showing one incident energy and arc flash boundary value.

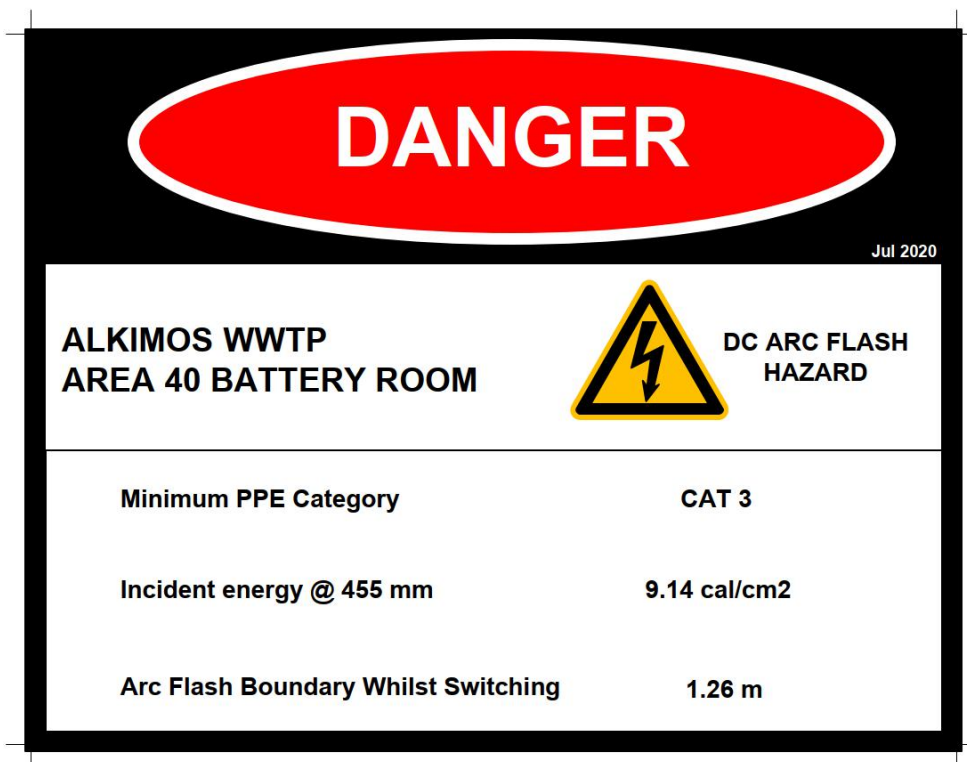

Figure 25 – DC Non-switchboard Arc Flash Warning Label Format

Where the arc flash hazard rating category is Cat 0 or DC incident energy calculations are not required (refer to Section 1.7) the warning label need only include a danger symbol, indicate the presence of an arc flash risk and nominate Cat 0 PPE. The format is as shown on the label in Section 8 for the short-hand AC calculation method.

## 15.7 Where DC Incident Energy Calculations are not Required

Table 12 provides a screening tool which can be used to quickly determine when DC arc flash calculations are required. The table summarises the DC bolted fault level thresholds required to yield an incident energy of 1.2 cal/cm<sup>2</sup> for different DC source voltage levels. Where the bolted fault levels are lower than the tabulated values the incident energy is less than 1.2 cal/cm<sup>2</sup> (Cat 0) and thus arc flash calculations are not required. Minimum DC bolted fault current values for voltages in-between the discrete values listed in the table can be interpolated from the values provided.

| Voltage (V) | DC Bolted Fault Current – 1.2 cal/cm <sup>2</sup> thresholds (A) |
|-------------|--|
| 60          | 12,000   |
| 65          | 5,600  |
| 70          | 3,900  |
| 75          | 3,100  |
| 80          | 2,600  |
| 85          | 2,300  |
| 100         | 1,700  |
| 150         | 1,225  |
| 200         | 875  |
| 500         | 350  |
| 1,000       | 175  |

Table 12 – DC Bolted Fault Current – 1.2 cal/cm<sup>2</sup> Thresholds

The following scenarios are examples where DC arc flash energy levels are insignificant, and assessment is not required:

- Engine starting battery systems – The incident energy for an arc fault on a typical 12V VRLA battery is very low based on an Ammerman assessment ( $2 \times 10^{-7}$  cal/cm<sup>2</sup> at a 455mm working distance, for a 2s arc duration)
- DC Power supplies and battery chargers – the fault current is typically electronically limited to less than 150% of the full load current
- PV panels, battery systems and other DC sources where the voltage is below 60V, as the incident energy does not present a risk at lower voltages

## 15.8 DC Arc Flash Mitigation

Arc flash hazard mitigation measures shall be implemented, so far as is reasonably practicable, where the hazard rating category is above Cat 1.

DC arc flash hazards can be mitigated by reducing the likelihood of an arcing fault occurring and by reducing the incident energy if a fault occurs.

The following design approaches are possible methods of reducing the likelihood of an arcing fault occurring:

- Reduce the opportunity for workers to contact live DC terminals by using barriers and insulation over energised conductive parts. For example, potential points of contact exist at the conductive connection links between batteries, the battery terminals and exposed cable termination points. Moulded plastic covers, heat shrink insulation, plastic boots, etc. can be specified to cover these exposed conductive areas to reduce the risk of initiation of an arcing fault due to inadvertent contact with live parts
- DC installations can be made ‘arc resistant’ by separating opposite polarity DC terminals by at least 305mm. *The value of 305mm is based on the recommendations from IEEE Std 1187-2013, IEEE Recommended Practice for Installation Design and Installation of Valve-Regulated Lead-Acid Batteries for Stationary Applications. IEEE Std 1187-2013 explains that the risk of arc flash is significantly reduced if there is at least 305mm of space between DC potentials over 100V, as arcs are unsustainable for DC voltages under 600V at this separation.* This should be done where possible, especially where barriers or insulation over live terminals are not practical
- Provide an easy means of disconnecting battery strings or modules using a plug or similar method. The figure below shows an example of how a battery string can be designed with pluggable disconnection points to allow the string to be broken down into 100V battery segments to reduce arc flash hazards

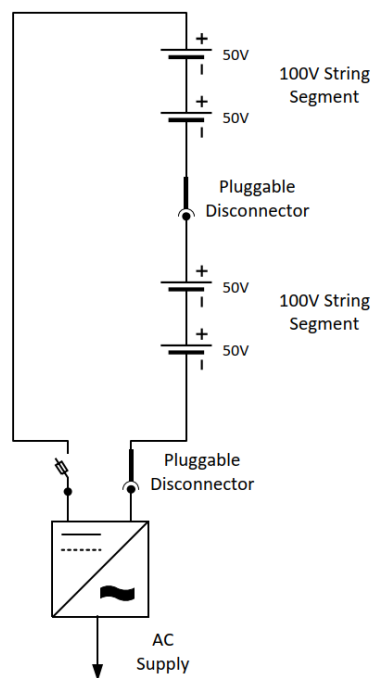

Figure 26 – Battery String Disconnection Method - Example

- Specifying battery systems with monitoring and alarming functions, which can provide early warning of conditions which could lead to or increase the likelihood of an arcing fault occurring

The following design approaches are possible methods of reducing the severity of the incident energy if an arc flash occurs:

- Arc flash incident energy is reduced at lower voltages. *According to IEEE Std 1187-2013, IEEE Recommended Practice for Installation Design and Installation of Valve-Regulated Lead-Acid Batteries for Stationary Applications, arc flash hazards for DC voltages less than 100V are insignificant, and there have not been documented cases of arc flash injuries for DC voltages under 100V in the U.S.* The design can include circuit breakers, fuse switches or isolators to enable battery strings to be separated into segments below 100V. This allows workers to reduce the arcing potential using switching procedures prior to commencing installation, commissioning, maintenance, repair or replacement activities

- 
- Select protection devices and settings to achieve rapid clearance if an arcing fault occurs. Fault current limiting fuses or moulded case circuit breakers can be used. The design shall ensure that the protective device specified will operate in its fault current limiting range at the calculated branch arcing fault current
  - For larger PV panel and battery installations consider using intermediate enclosures to combine multiple strings each with fault current limiting protection prior to connecting to a main DC switchboard or DC panel/enclosure. Fault current limiting devices shall also be used on the feeders between combiner boxes and the main DC switchboard or DC panel/enclosure . The number of intermediate enclosures and strings per combiner box should be selected considering the overall layout of the facility, the location of DC sources, as well as sizing of the fault current limiting current devices as required to provide effective arc flash incident energy limitation
  - Arc Flash detection – use light sensors for early detection of arcing faults and to initiate rapid interruption via circuit breakers

## 15.9 DC Arc Flash Example Calculations

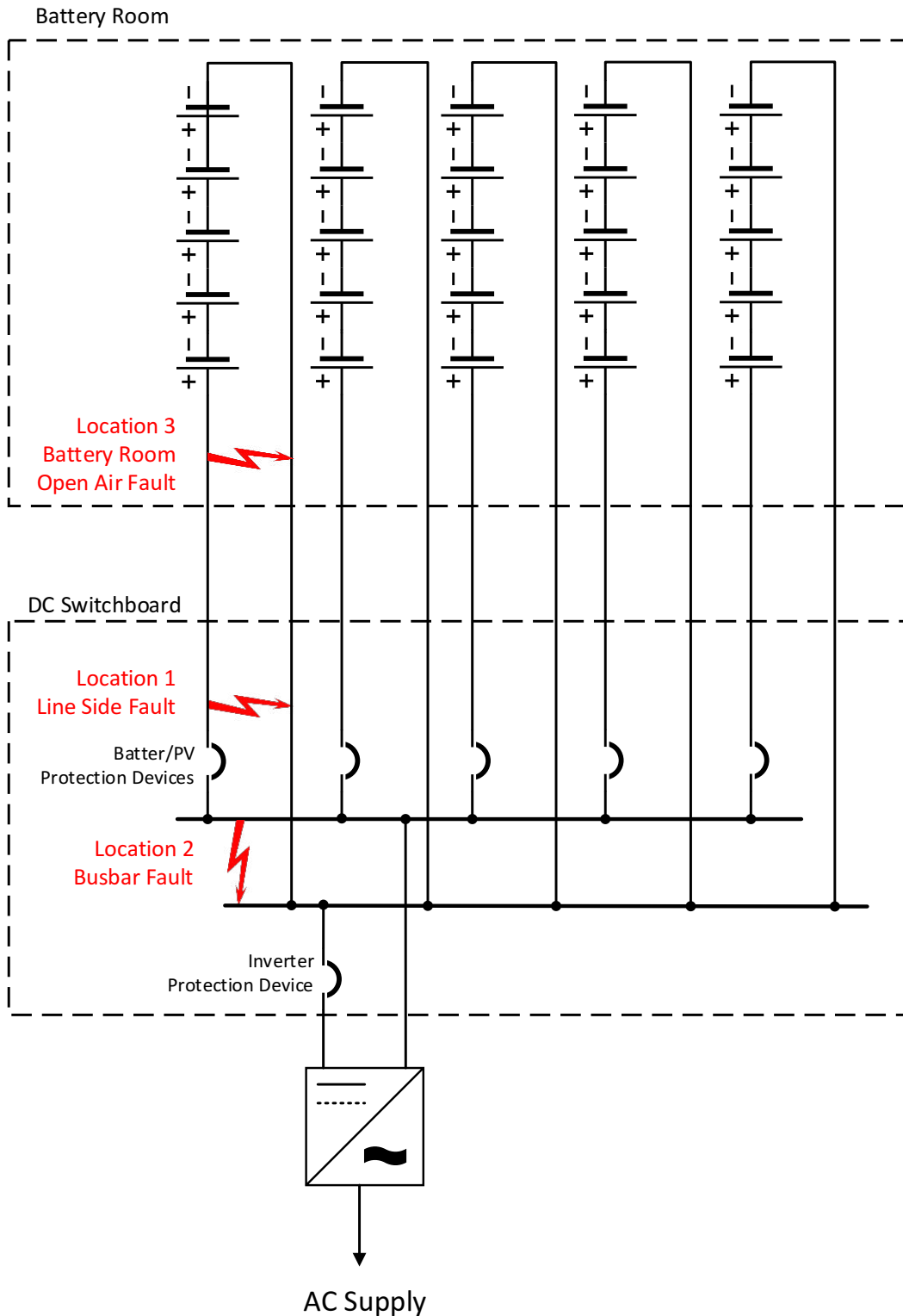

| DC Components                  | Details                           |
|--------------------------------|-----------------------------------|
| String Voltage                 | 120V (5x24V batteries per string) |
| Number of strings (parallel)   | 5                                 |
| Internal resistance of battery | 0.005 Ohms                        |
| Cable impedance                | Assume negligible                 |
| Arc gap                        | 25 mm                             |
| Working distance               | 455 mm                            |

$$1) I_b = \frac{V_{DC}}{R_{source}} = \frac{V_{DC}}{R_{Battery} + R_{Cable}}$$

$$= \frac{120V}{\frac{0.005 \times 5}{5 \text{ Strings}} + 0} = 24,000 \text{ Amps}$$

2) 1st Iteration

$$I_{arc,1} = 0.5 \times I_b = 12,000 \text{ Amps}$$

$$R_{arc,1} = \frac{20 + (0.534 \times \text{Arc Gap})}{I_{arc,1}^{0.88}}$$

$$= \frac{20 + (0.534 \times 25)}{12,000^{0.88}} = 0.008579 \Omega$$

3) 2nd Iteration

$$I_{arc,2} = \frac{V_{DC}}{R_{Battery} + R_{Cable} + R_{arc}}$$

$$= \frac{120}{0.005 + 0 + 0.008579} = 8,837.44 \text{ Amps}$$

$$R_{arc,2} = \frac{20 + (0.534 \times \text{Arc Gap})}{I_{arc,2}^{0.88}} = 0.011229 \Omega$$

4) 3<sup>rd</sup> Iteration

$$I_{arc,3} = 7,394.32 \text{ Amps}$$

$$R_{arc,3} = 0.013136 \Omega$$

5) 4<sup>th</sup> Iteration

$$I_{arc,4} = 6,616.65 \text{ Amps}$$

$$R_{arc,4} = 0.014486 \Omega$$

6) 5<sup>th</sup> Iteration

$$I_{arc,5} = 6,158.42 \text{ Amps}$$

$$R_{arc,5} = 0.015430 \Omega$$

7) 6<sup>th</sup> Iteration

$$I_{arc,6} = 5,873.74 \text{ Amps}$$

$$R_{arc,6} = 0.016086 \Omega$$

8) 28<sup>th</sup> Iteration

$$I_{arc,7} = 5,324.34 \text{ Amps}$$

$$R_{arc,7} = 0.017538 \Omega$$

Example 1 – Fault inside of the DC Switchboard

1) Incident energy calc and boundary @ Location 2 (busbar fault)

The fault contribution from each battery string is 1,064.87 Amps  $\left(\frac{5,324.34 \text{ Amps}}{5 \text{ strings}}\right)$

The DC string circuit breakers trip in 100ms.

$$\begin{aligned} \text{Incident energy @ 455mm} &= \frac{I_{arc}^2 \times R_{arc} \times t_{arc} \times k \times 23.9}{455^2 + a^2} \\ &= \frac{(1,064.87 \times 5)^2 \times 0.017538 \times 0.1 \times 0.312 \times 23.9}{455^2 + 400^2} \\ &= 1.01 \text{ Cal/cm}^2 \end{aligned}$$

PPE Category = CAT 0



$$\begin{aligned}
 AFB &= \sqrt{I_{arc}^2 \times R_{arc} \times t_{arc} \times 3.487} \\
 &= \sqrt{(1,064.87 \times 5)^2 \times 0.017538 \times 0.1 \times 3.487} \\
 &= 416 \text{ mm}
 \end{aligned}$$

2) Incident energy calc and boundary @ Location 1 (line side fault).

The fault contribution from each battery string is 1,064.87 Amps ( $\frac{5,324.34 \text{ Amps}}{5 \text{ strings}}$ )

There is no protection to trip the fault current from the battery string on which the fault is located. For this string, 2s is used as the theoretical maximum trip time (in accordance with the 2s rule described in IEEE Std. 1584).

The other 4 x battery strings also supply fault current into the fault location. For these strings their respective protection circuit breakers trip in 100ms.

For the first 0.1s all five of the battery strings supply fault current into the fault location. Energy contribution for 0.1s:

$$\begin{aligned}
 \text{Incident energy @ 455mm} &= \frac{I_{arc}^2 \times R_{arc} \times t_{arc} \times k \times 23.9}{455^2 + a^2} \\
 &= \frac{(1,064.87 \times 5)^2 \times 0.017538 \times 0.1 \times 0.312 \times 23.9}{455^2 + 400^2} \\
 &= 1.01 \text{ Cal/cm}^2
 \end{aligned}$$

After 0.1s four of the five battery strings have tripped and are no longer supplying fault current. The battery string on which the fault is located continues to supply fault current into the fault location for an additional 1.9s (to reach the theoretical maximum trip time of 2s).

Energy contribution for 1.9s:

$$\begin{aligned}
 \text{Incident energy @ 455mm} &= \frac{I_{arc}^2 \times R_{arc} \times t_{arc} \times k \times 23.9}{455^2 + a^2} \\
 &= \frac{(1064.87)^2 \times 0.017538 \times (2 - 0.1) \times 0.312 \times 23.9}{455^2 + 400^2} \\
 &= 0.768 \text{ Cal/cm}^2
 \end{aligned}$$

Accumulated Energy:

$$= 1.01 + 0.768 = 1.78 \text{ Cal/cm}^2$$

*PPE Category = CAT 1*

$$AFB = \sqrt{\{[(I_1 + I_2)^2 \times t_1] + [I_2^2 \times (t_2 - t_1)] \times R_{arc} \times 3.487\}}$$

$$= \sqrt{\{[(1064.87 \times 4) + 1064.87^2 \times 0.1] + [1064.87^2 \times (2 - 0.1)] \times 0.017538 \times 3.487\}} = 552 \text{ mm}$$

## Example 2 – Fault inside of the Battery Room

### 1) Incident energy calc and boundary @ Location 3 (open air fault)

The fault contribution from each battery string is 1,064.87 Amps ( $\frac{5,324.34 \text{ Amps}}{5 \text{ strings}}$ )

There is no protection to trip the fault current from the battery string on which the fault is located. For this string, 2s is used as the theoretical maximum trip time (in accordance with the 2s rule described in IEEE Std. 1584).

The other 4 x battery strings also supply fault current into the fault location. For these strings their respective protection circuit breakers trip in 100ms.

For the first 0.1s all five of the battery strings supply fault current into the fault location.

Energy contribution for 0.1s:

$$\text{Incident energy @ 455mm} = \frac{I_{arc}^2 \times R_{arc} \times t_{arc} \times 1.902}{455^2}$$

$$= \frac{(1,064.87 \times 5)^2 \times 0.017538 \times 0.1 \times 1.902}{455^2}$$

$$= 0.457 \text{ Cal/cm}^2$$

After 0.1s four of the five battery strings have tripped and are no longer supplying fault current. The battery string on which the fault is located continues to supply fault current into the fault location for an additional 1.9s (to reach the theoretical maximum trip time of 2s).

Energy contribution for 1.9s:

$$\text{Incident energy @ 455mm} = \frac{I_{arc}^2 \times R_{arc} \times t_{arc} \times 1.902}{455^2}$$

$$= \frac{1064.87^2 \times 0.017538 \times (2 - 0.1) \times 1.902}{455^2}$$

$$= 0.347 \text{ Cal/cm}^2$$

Accumulated Energy:

$$= 0.457 + 0.347 = 0.804 \text{ Cal/cm}^2$$

*PPE Category = CAT 0*

$$AFB = \sqrt{\frac{\{(I_1 + I_2)^2 \times t_1\} + [I_2^2 \times (t_2 - t_1)]}{0.631}} \times R_{arc}$$
$$= \sqrt{\frac{\{[(1064.87 \times 4) + 1064.87]^2 \times 0.1\} + [1064.87^2 \times (2 - 0.1)]}{0.631}} \times 0.017538 = 372mm$$

END OF DOCUMENT